

•This service manual does not include information on the CD mechanism assembly (exploded view, parts list, schematic diagram or mechanism operation description).
For such information, please refer to the CD mechanism assembly service manual (X92-4450-0X: B51-7889-00).

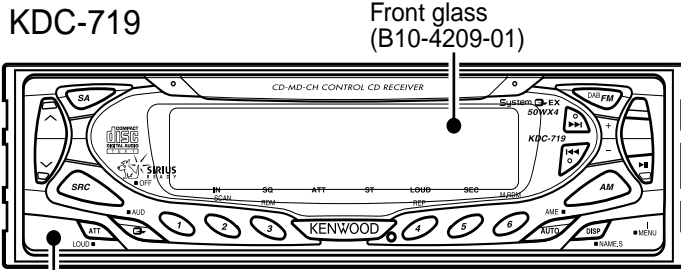

Panel assy (A64-2646-11)

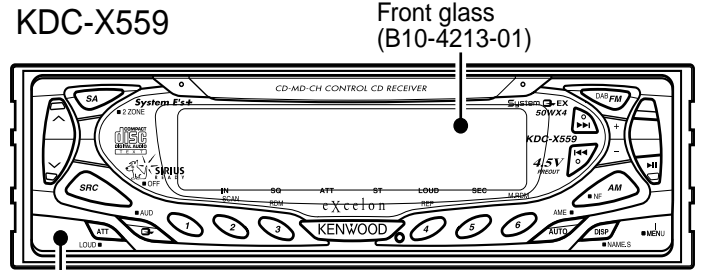

Panel assy (A64-2650-11)

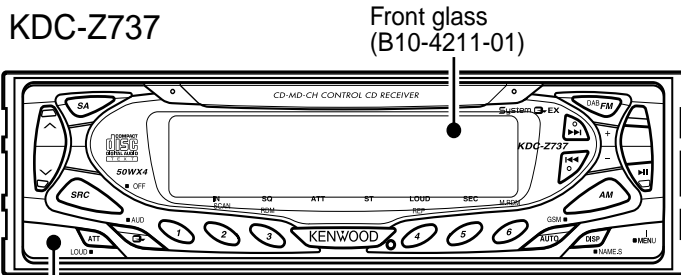

Panel assy (A64-2648-11)

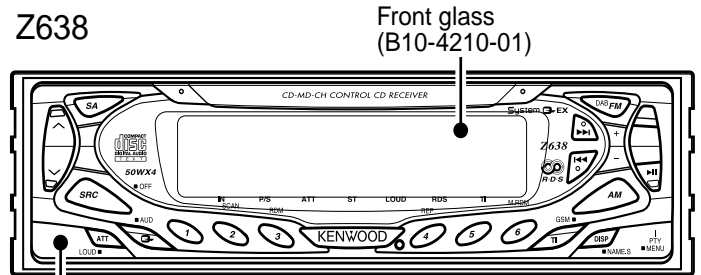

Panel assy (A64-2647-11)

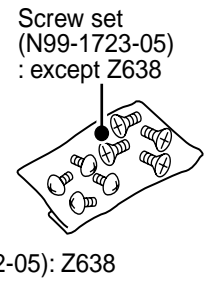
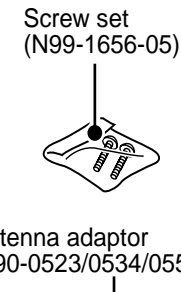
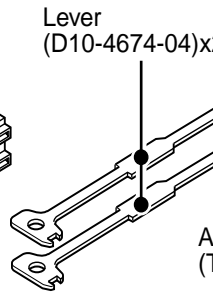
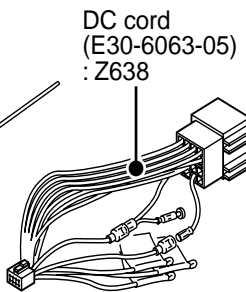
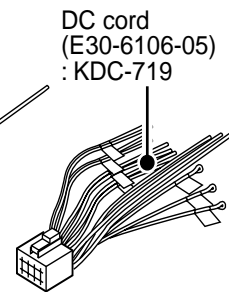
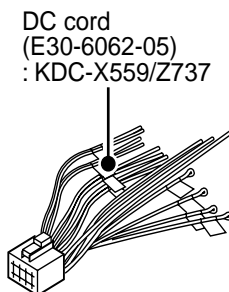
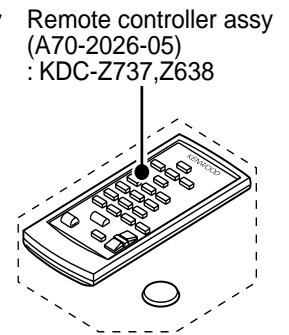
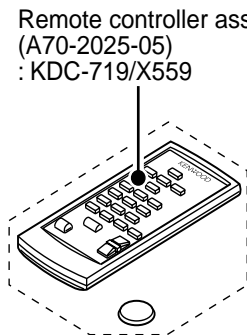
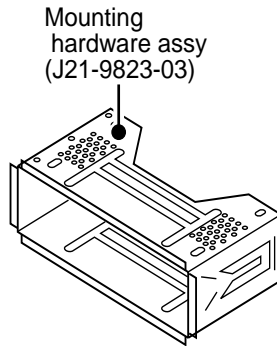
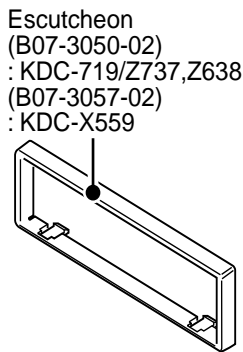
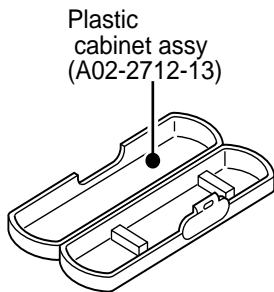

BLOCK DIAGRAM

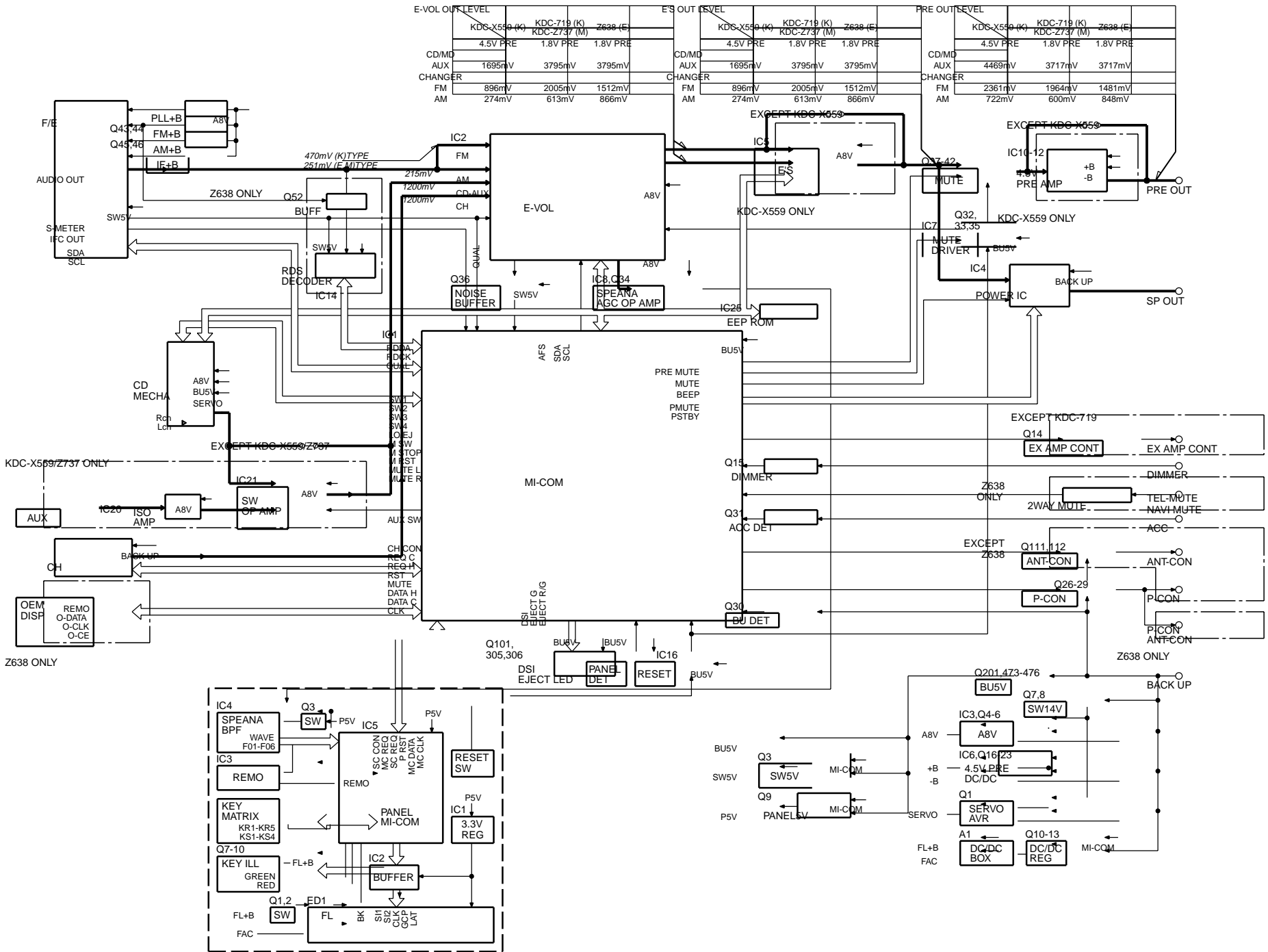

COMPONENTS DESCRIPTION

SWITCH UNIT (X16-168x-xx)

Ref.No.	Component Name	Application/Function	Operation/Condition/Compatibility
IC1	TAR5S33	FL AVR	+3.3V Output
IC2	TC74HC4050AFT	Buffer	For FL control lines, 5V→3.3V logic level shifting
IC3	RS-171	Remote sensor IC	
IC4	BA3830F	BPF IC	BPF for the spectrum analyser indicator
IC5	UPD703032GFA04	Panel MI-COM.	
Q1	DTA144EUA or UN5113	FL+B SW	FL & Illumination +B ON/OFF control. When Q2's base goes Hi, Q1 is turned on, and FL+B (45V) line is supplied to FL indicator and the key illumination circuit.
Q2	DTC114YUA or UN5214		
Q3	DTA114EUA or UN5111	REMO SW	When a base goes Lo, Q3 is turned on, and PAN5V line is supplied to IC3 and IC4.
Q4	DTC114EUA or UN5211	FL blanking SW	When a base goes Hi, Q4 is turned on, and FL indicator is lit.
Q6	DTC114YK or UN2214	SRC key illumination SW	When a base goes Hi, Q6 is turned on, and SRC illumination is lit.
Q7	2SC4081	V-I converter	Current driver for green LEDs
Q8	2SC4081	V-I converter	Current driver for red LEDs
Q9	DTA114EUA or UN5111	Key illumination Red SW	When a base goes Lo, Q9 is turned on, and key illumination Red is lit.
Q10	DTA114EUA or UN5111	Key illumination Green SW	When a base goes Lo, Q10 is turned on, and key illumination Green is lit.

ELECTRIC UNIT (X25-924x-xx)

Ref.No.	Component Name	Application/Function	Operation/Condition/Compatibility
IC1	UPD703033GFA18	System MI-COM.	
IC2	TDA7407	E-VOL.& N.C. MPX	
IC3	M5237ML	AVR IC	IC is combined with Q4, and it works as the error detection, the Q4's driver.
IC4	TDA7560	Power IC	
IC5	TDA7401	High pass filter & Non-Fader volume	HPF (Front/Rear output), LPF, Non-Fader switching and volume function
IC6	ICL7660SIBA	DC/DC converter	-9V AVR for pre-output amplifier
IC7	TC74HC02AF	Mute logic	2-input NOR x 4
IC8	NJM4565M-TE2	Op. amp.	Amplifier for the spectrum analyser and generation of Vref. (1/2Vcc) voltage
IC10	NJM4565M-TE2	Op. amp.	Amplifier for the front pre-outputs
IC11	NJM4565M-TE2	Op. amp.	Amplifier for the non-fader pre-outputs
IC12	NJM4565M-TE2	Op. amp.	Amplifier for the rear pre-outputs
IC14	TDA7479D	RDS decoder	
IC16	S-80837ANNP	Reset IC	When BU 5V voltage is less than 3.7V, IC outputs Lo.
IC20	BA3121F	Isolation amplifier	AUX inputs isolation amplifier
IC21	BA3129F	Switched op.amp.	Input switching with AUX inputs and CD inputs
IC25	BR24C02F-W	EEPROM	
Q1	2SD2375	CD servo AVR	AVR for CD mechanism servo operation, +7.5V output.
Q3	2SA1037K	SW 5V	While a base goes Lo, SW 5V is supplied to the microprocessor peripheral circuits.
Q4	2SA2057	A.+8V AVR	Q4 is combined with IC3, and it works as the power supply of +8.0V output.
Q5	DTC144EUA or UN5213	A.+8V AVR SW	When Q5's base goes Hi, Q6 is turned on, and A.+8V AVR is working.
Q6	DTA124EUA or UN5112		
Q7	DTA124EUA or UN5112	SW14V	When Q8's base goes Hi, Q7 is turned on, and A.+8V AVR, CD servo AVR and A+10V AVR are working.
Q8	DTC124EUA or UN5212		
Q9	2SB1427	PAN5V SW	For PAN5V on/off switching. When a base goes Lo with panel attached to the set, Q9 is turned on, and PAN5V is supplied to the panel.
Q10	2SA2057	FL/Illumination AVR	When Q11's base goes Hi, AVR outputs +9V.
Q11	2SC4081		

COMPONENTS DESCRIPTION

Ref.No.	Component Name	Application/Function	Operation/Condition/Compatibility
Q12	DTC124EUA or UN5212	FL/Illumination AVR SW	When Q12' base goes Hi, Q13 is turned on, and FL/Illumination AVR is working.
Q13	DTA124EUA or UN5112		
Q14	DTA123JK or KRA105S	EXT. AMP CON. SW	When a base goes Lo, Q14 is turned on, and control pulse signal is outputted.
Q15	DTC144EUA or UN5213	Dimmer detection SW	When vehicle small lamps turn on, Q15's base goes Hi, and it is turned on .
Q16	2SB1443	A.+10V AVR	When Q17's base goes Hi, AVR outputs +10V.
Q17	2SC4081		
Q18	2SA1576A	PRE-AMP -9V AVR	Q18 and Q20 work as a differential amplifier, Q19 works as a driver, and -9.3V is supplied to OP AMP.
Q19	2SC4081		
Q20	2SA1576A		
Q21	2SC4081	PRE-AMP +9V AVR	Q21and Q22 work as a differential amplifier, Q23 works as a driver, and +9.7V is supplied to OP AMP.
Q22	2SC4081		
Q23	2SA1576A		
Q26	2SB1277(Q,R)	P-CON SW	When Q29's base goes Hi, Q26 is turned on, and P-CON signal is outputted. Works during POWER ON mode.
Q29	DTC114YUA or UN5214		
Q27	2SA1576A	P-CON. protection SW	Protect Q26 by turning ON when P-CON output is grounded.
Q28	DTA124EUA or UN5112	P-CON. protection inhibit SW	Prevents Q27 tuning ON during start-up after power ON.
Q30	2SC4081	BU detection SW	While BACKUP is applied, a base goes Hi, and Q30 is turned on. When momentary power down has detected, a base goes Lo, and Q30 is turned off.
Q31	2SC4081	ACC detection SW	While ACC is applied, a base goes Hi, and Q31 is turned on.
Q32	DTA124EUA or UN5112	Mute driver for R Ch.	When BU detection SW or System RESET or MI-COM.'s MUTE is working, a base goes Lo, and Q32 and Q33 are turned on.
Q33	DTA124EUA or UN5112	Mute driver for L Ch.	
Q34	2SC4081	AGC for spectrum analyser	
Q35	DTC124EUA or UN5212	E. VOL. mute SW	When BU detection SW or MI-COM.'s mute is working, a base goes Hi, and Q35 is turned on.
Q36	DTC143TUA or UN5216	Noise buffer	
Q37	DTC143TUA or UN5216	Audio mute SW (Front L)	When Q37's base goes Hi, Pre-output is muting.
Q38	DTC143TUA or UN5216	Audio mute SW (Front R)	When Q38's base goes Hi, Pre-output is muting.
Q39	DTC143TUA or UN5216	Audio mute SW (Non Fader R)	When Q39's base goes Hi, Pre-output is muting.
Q40	DTC143TUA or UN5216	Audio mute SW (Non Fader L)	When Q40's base goes Hi, Pre-output is muting.
Q41	DTC143TUA or UN5216	Audio mute SW (Rear L)	When Q41's base goes Hi, Pre-output is muting.
Q42	DTC143TUA or UN5216	Audio mute SW (Rear R)	When Q42's base goes Hi, Pre-output is muting.
Q43	DTC124EUA or UN5212	FM+B SW	When Q43's base goes Hi, Q44 is turned on, and A.+8V is supplied to the F/E. Works during FM reception mode or RDS reception mode.
Q44	CPH3105		
Q45	DTC124EUA or UN5212	AM+B SW	When Q45's base goes Hi, Q46 is turned on, and A.+8V is supplied to the F/E. Works during AM reception mode.
Q46	CPH3105		
Q52	DTC143TUA or UN5216	Composite signal buffer	
Q101	DTA114YUA or UN5114	DSI LED SW	When a base goes Lo, Q101 is turned on, and DSI illumination LED is lit.
Q103	DTC124EUA or UN5212	AUX/CD selector SW	When a base goes Hi, AUX inputs are selected. When a base goes Lo, CD inputs are selected.
Q111	2SB1277(Q,R)	P-ANT SW	When Q112's base goes Hi, Q111 is turned on, and P-ANT signal is outputted. Works during FM/AM reception mode or RDS reception mode.
Q112	DTC114YUA or UN5214		
Q201	2SC4081	BU5V discharge SW	When BU OFF is detected, Q201 is turned on during the base Hi condition.
Q305	DTA114YUA or UN5114	EJECT LED Red SW	When a base goes Lo, Q305 is turned on, and EJECT illumination LED is lit.
Q306	DTA114YUA or UN5114	EJECT LED Green SW	When a base goes Lo, Q306 is turned on, and EJECT illumination LED is lit.
Q473	2SC4081	BU 5V AVR	While BACKUP is applied, AVR outputs +5V. Q473 and Q474 are inverted Darlington connection.
Q474	2SB1548(P)		
Q475	2SC4081	Voltage converter	Q475 and Q476 work as voltage coverter for BU 5V AVR, and it output +9V.
Q476	2SB1548(P)		

MICROCOMPUTER'S TERMINAL DESCRIPTION

IC5 (SWITCH UNIT: X16-168x-xx)

Pin No.	Pin Name	I/O	Description	Processing Operation
1	SC DATA	I/O	Data input/output with the system MI-COM.	
2	MC CLK	I	Clock input from the system MI-COM.	
3	NC	O		Not used (N.C.)
4	DATA 1	O	Data output 1 to the FL driver IC	
5	CLK	O	Clock output to the FL driver IC	(Data shift by the rise edge of the pulse)
6	NC	O		Not used (N.C.)
7	DATA 2	O	Data output 2 to the FL driver IC	
8	CLK IN	I	Clock input from the FL driver IC	(Data shift by the rise edge of the pulse)
9	EVDD	-	Positive power supply connection terminal	Connected to P5V lines.
10	EVSS	-	Ground connection terminal	Connected to GND lines.
11	RED LED	O	Illumination red ON/OFF output in case of two colours /Illumination ON/OFF output in case of one colour	Lo: ON, Hi: OFF
12	GREEN LED	O	Illumination green ON/OFF output in case of two colours /Not used in case of one colour	Lo: ON, Hi: OFF in case of two colours /Not used (N.C.) in case of one colour
13	REMO	I	Data input from the remote control light sensor	
14	LATCH	O	Latch output to the FL driver IC	Lo: Latch, Hi: Through
15	GCP	O	Control pulse output to the FL brightness	
16	REMO ON	I/O	Power supply ON/OFF output to the remote control light sensor IC and BPF IC	Lo: ON, Hi-Z: OFF
17-19	NC	O		Not used (N.C.)
20	BLK	O	Display ON/OFF control output	Lo: Display OFF, Hi: Display ON
21	TEST	I	Test terminal	Not used (Connected to GND lines)
22-33	NC	O		Not used (N.C.)
34	RESET	I	Reset terminal	Lo: Reset, Hi: Reset release
35	XT1	-	Sub clock resonator connection terminal	Not used (Pull down to GND lines)
36	XT2	-	Sub clock resonator connection terminal	Not used (N.C.)
37	REGC	-	Capacitor connection terminal for regulator inside microprocessor	
38	X2	-	Main clock resonator connection terminal	
39	X1	-	Main clock resonator connection terminal	
40	VSS	-	Ground connection terminal	Connected to GND lines.
41	VDD	-	Positive power supply connection terminal	Connected to P5V lines.
42-47	NC	O		Not used (N.C.)
48	FL +3.3V	O	FL VDD ON/OFF output	Lo: OFF, Hi: ON
49	FL+B	I/O	FL+B ON/OFF output	Hi-Z: OFF, Hi: ON
50-55	NC	O		Not used (N.C.)
56	BLUE LED	I/O	Source key LED ON/OFF output	Hi-Z: OFF, Hi: ON
57	NC	O		Not used (N.C.)
58	BVDD	-	Positive power supply connection terminal	Connected to P5V lines.
59	BVSS	-	Ground connection terminal	Connected to GND lines.
60-71	NC	O		Not used (N.C.)

MICROCOMPUTER'S TERMINAL DESCRIPTION

Pin No.	Pin Name	I/O	Description	Processing Operation
72	SA RESET	O	Reset output to the BPF IC	Hi: Reset
73	NC	O		Not used (N.C.)
74	AVDD	-	A/D converter positive power supply connection terminal	Connected to P5V lines.
75	AVSS	-	A/D converter ground connection terminal	Connected to GND lines.
76	AVREF	-	A/D converter reference voltage input terminal	
77	F01	I	BPF (63Hz) input	
78	F02	I	BPF (150Hz) input	
79	F03	I	BPF (330Hz) input	
80	F04	I	BPF (1kHz) input	
81	F05	I	BPF (3.3kHz) input	
82	F06	I	BPF (10kHz) input	
83	WAVE IN	I	Audio input	
84	KR5	I	Key return 5 input	
85	KR4	I	Key return 4 input	
86	KR3	I	Key return 3 input	
87	KR2	I	Key return 2 input	
88	KR1	I	Key return 1 input	
89	SC REQ	O	Communication request output to the system MI-COM.	Lo: Standby, Hi: Request
90	NC	O		Not used (N.C.)
91	SC CON	I	Control input from the system MI-COM.	Hi: Operation mode
92	NC	O		Not used (N.C.)
93	SOURCE	I	Source key input	Lo: Key OFF, Hi: Key ON
94	VREF CON	O	A/D converter reference voltage control output	Hi: Active, Connected to AVREF terminal
95	MC REQ	I	Communication request input from the system MI-COM.	Hi: Request
96	KS4	I/O	Key scan output 4	
97	KS3	I/O	Key scan output 3	
98	KS2	I/O	Key scan output 2	
99	KS1	I/O	Key scan output 1	
100	MC DATA	I	Data input from the system MI-COM.	

IC5 (ELECTRIC UNIY: X25-9240-xx)

Pin No.	Pin Name	I/O	Description	Processing Operation
1	MC DATA	I/O	Data input/output with the panel MI-COM.	
2	MC CLK	O	Clock output to the panel MI-COM.	
3	DSI GUIDE	I/O	DSI control output	Lo: DSI ON, Hi-Z: DSI OFF Lights on at the panel tilted during POWER ON mode. Flashing at the panel detached during POWER ON mode.
4	EJECT KEY G	O	Eject key illumination green control output	Lo: ON, Hi-Z: OFF Lights on at the panel tilted during POWER ON mode in case of the key illumination green.

MICROCOMPUTER'S TERMINAL DESCRIPTION

Pin No.	Pin Name	I/O	Description	Processing Operation
5	EJECT KEY R/G	O	Eject key illumination red/green control output	Lo: ON, H-Z: OFF Lights on at the panel tilted during POWER ON mode.
6	MC REQ/FLIP DET	I/O	Communication request output to the panel MI-COM. /Flip detection input	Hi: Request /Lo: Panel detected, Hi: Panel attached
7	IC2 SDA	I/O	Data input/output with IC2, IC5, and IC25	
8	IC2 SCL	I/O	Clock input/output with IC2, IC5, and IC25	
9	EVDD	-	Positive power supply connection terminal	Connected to BU 5V lines.
10	EVSS	-	Ground connection terminal	Connected to GND lines.
11	PAN RESET	O	Reset output to the panel MI-COM.	Lo: Reset or Momentary power down detected
12	BEEP	O	BEEP output	
13	REMO	I	Data input from the wired remote control	
14	SVR	O	SVR output	Not used (N.C.)
15	DIMMER	I	Small lights detection input	Lo: During vehicle small lamps turn on
16	PLL DATA	I/O	Data input/output with F/E	
17	PLL CLK	I/O	Clock input/output with F/E	
18	P-STBY	O	POWER IC STBY output	Lo: Power IC OFF, Hi: Power IC ON or ALL OFF mode
19	P-CON	I/O	P-CON output	Hi-Z: POWER OFF mode or ALL OFF mode, Hi: POWER ON mode
20	ANT-CON	O	ANT-CON output	Hi: During TUNER mode or last FM mode with RDS/RBDS model
21	TEST	-	Test terminal	Not used (Connected to GND lines)
22	P MUTE	O	POWER IC mute output	Lo: Muting during POWER OFF mode, ALL OFF mode and TEL MUTE ON
23	PAN5V	I/O	Panel 5V control output	Lo: Panel attached normally, Hi-Z: Panel detached or tilted
24	EXT-AMP-CON	O	External amp. control output (in 200msec)	Bass boost OFF__Hi: 160msec, Lo: 40msec Bass boost LOW__Hi: 130msec, Lo: 70msec Bass boost HI__Hi: 100msec, Lo: 100msec
25	CD MECHA+B	I/O	CD4.7V ON/OFF output	Not used (N.C.)
26	EMUTE	O		Not used (N.C.)
27	BU DET	I	Momentary power down detection input	Lo: BU ON, Hi: When momentary power down detected or BU OFF
28	ACC DET	I	ACC detection terminal	Lo: ACC ON, Hi: ACC OFF
29	SW5V	I/O	SW5V control terminal	Lo: SW5V ON, Hi-Z: SW5V OFF
30	MUTE	I/O	MUTE output	Lo: Muting OFF, Hi-Z: Muting ON
31	O CE	I/O	External display CE terminal	
32	O CLK	I/O	External display clock terminal	
33	O DATA	I/O	External display data terminal	
34	RESET	I	Reset input	Lo: System reset , Hi: Normal operation
35	XT1	I	Sub clock resonator connection terminal	Clock count during POWER OFF mode
36	XT2	-	Sub clock resonator connection terminal	

MICROCOMPUTER'S TERMINAL DESCRIPTION

Pin No.	Pin Name	I/O	Description	Processing Operation
37	REGC	-	Capacitor connection terminal for regulator inside microprocessor	
38	X2	-	Main clock resonator connection terminal	Oscillation: POWER ON mode, Oscillation stop: POWER OFF mode or momentary power down detected
39	X1	I	Main clock resonator connection terminal	
40	VSS	-	Ground connection terminal	Connected to GND lines.
41	VDD	-	Positive power supply connection terminal	Connected to BU 5V lines.
42	CLKOUT	O	Internal system clock output	Not used (N.C.)
43	NC	O		Not used (N.C.)
44	E2PDET	I	EEPROM detection input	Lo: No EEPROM, Hi: With EEPROM
45	PRE MUTE L	O	Pre-out muting L Ch. control output	Lo: When M MUTE L input is Lo during CD source selected or Momentary power down detected, Hi: Fix in the case of 2 zone mode
46	PRE MUTE R	O	Pre-out muting R Ch. control output	Lo: When M MUTE R input is Lo during CD source selected or Momentary power down detected, Hi: Fix in the case of 2 zone mode
47	DSP DATA	O	Data output to DSP IC	Not used (N.C.)
48	DSP LATCH	O	Latch output to DSP IC	Not used (N.C.)
49	DSP CLK	O	Clock output to DSP IC	Not used (N.C.)
50	AFS	O	Noise detection time constant switching terminal	Lo: During FM seek or AF search, Hi: During FM reception, Hi: During last FM mode with RDS/RDBS model
51	AM+B	I/O	AM+B control	Hi: During AM reception
52	FM+B	I/O	FM+B control	Hi: During FM reception, Hi: During last FM mode with RDS/RDBS model
53	R QUAL	I	Quality input from the RDS decoder IC	Except RDS, RBDS model: Not used (pull down to GND lines)
54	R DATA	I	Data input from the RDS decoder IC	Except RDS, RBDS model: Not used (pull down to GND lines)
55	IC2TYPE0	I	IC2 setting terminal	Lo: Initial value (default)
56	IC2TYPE1	I	IC2 setting terminal	Lo: Initial value (default)
57	P ON	I/O	SW 14V control output	Hi-Z: POWER OFF mode, Hi: POWER ON mode
58	BVDD	-	Positive power supply connection terminal	Connected to BU 5V lines.
59	BVSS	-	Ground connection terminal	Connected to GND lines.
60	TYPE0	I	Destination type selection terminal 0	
61	TYPE1	I	Destination type selection terminal 1	
62	TYPE2	I	Destination type selection terminal 2	
63	TYPE3	I	Destination type selection terminal 3	
64	AUX SW	O	CD/AUX input switching output	Lo: Except AUX input, Hi: AUX input
65	ILL ON	I/O	FL/Illumination AVR ON/OFF control output	Hi-Z: AVR OFF, Hi: AVR ON
66	MOSW	O	CD mechanism loading motor control output	Hi: CD loading/eject action or Break, Lo: Other
67	LO/EJ	I/O	CD mechanism loading/Eject switching output	Lo: Loading, Hi: Eject, Hi-Z: Stop or Break

MICROCOMPUTER'S TERMINAL DESCRIPTION

Pin No.	Pin Name	I/O	Description	Processing Operation
68	M STOP	O	Stop request to CD mechanism MI-COM.	Lo: Stop mode, Hi: Operation mode
69	M RST	O	Reset output to CD mechanism MI-COM.	Lo: Reset
70	CH CON	O	Changer control	Lo: Standby mode, Hi: Operation mode
71	CH RST	O	Reset output to changers	 : Reset
72	CH REQH	O	Request output to changers	Lo: Request
73	AVCONT	O	A/D converter reference voltage control output	Hi: Active, Connected to AVREF terminal
74	AVDD	-	A/D converter positive power supply connection terminal	Connected to BU 5V lines.
75	AVSS	-	A/D converter ground connection terminal	Connected to GND lines.
76	AVREF	I	A/D converter reference voltage input terminal	
77	IFC OUT	I	F/E IFC OUT input terminal	Hi: Station detected (Vth=2.5V)
78	S METER	I	S-meter input from F/E	
79	NOISE	I	FM noise detection input	
80,81	NC	I		Not used (Pull down to GND lines)
82	CD SW2	I	12cm disc detection SW input	Lo: 12cm disc detected
83	M MUTE R	I	Mute request (R Ch.) from CD mechanism MI-COM.	Lo: Mute request
84	M MUTE L	I	Mute request (L Ch.) from CD mechanism MI-COM.	Lo: Mute request
85	CD SW3	I	Down & limit switch detection input	Hi: Chucking, Hi→Lo: Pickup most inner position
86	PANEL DET	I	Panel detection input	Lo: Panel attached, Hi: Panel detached
87	CH MUTE	I	Mute request from changers	Hi: Mute request
88	PHONE	I	PHONE detection input	1V or less: TEL MUTE, 2.5V or greater: NAVI MUTE
89	SC CON	O	Control output to the panel MI-COM.	Hi: Operation mode
90	SOURCE	I/O	SOURCE key detection input	Not used (N.C.)
91	CD SW1	I	Loading SW detection input	Lo: Loading start
92	CD SW4	I/O	8cm disc detection SW input	Not used (N.C.)
93	R CLK	I	Clock input from the RDS decoder IC	Except RDS, RBDS model: Not used (pull down to GND lines)
94	CH REQC	I	Communication request input from changers	Lo: Request
95	EJECT	I	EJECT key detection input	Lo: When EJECT key is pressed
96	SC REQ	I	Communication request input from the panel MI-COM.	Hi: Request
97	CH DATAC	I	Data input from changers	
98	CH DATAH	O	Data output to changers	
99	CH CLK	I/O	Clock input/output with changers	
100	SC DATA	I	Data input from the panel MI-COM.	

TEST MODE

1. How to enter the test mode

While pressing and holding the Preset 1 and Preset 3 keys, re-set the unit.

2. How to exit from the test mode

Reset the unit, ACC OFF, power OFF and Panel detached.

(Note) The test mode cannot be terminated by momentary power down.

3. Initial status in the test mode

- Sources : ALL OFF
- Display : All segments are lit.
- Volume : -10 dB (displayed as "30")
- Loudness : OFF
- CRSC : OFF regardless of the presence of switching function.
- SYSTEM Q : Flat
- BEEP : When pressing any keys, the buzzer generates a beep at any time.

4. Special display in Tuner mode

When any of the following messages is displayed in Tuner mode, the F/E may be abnormal.

- "TNE2P NG" : The EEPROM is set to the default (unstable values) because the F/E was shipped without passing through the adjustment process, etc.
- "TNCON NG" : Communication with the F/E is not possible.

5. Forced switching of K3I

Each press of the Preset 6 key in Tuner mode should switch K3I from AUTO → Forced Wide → Forced Middle → Forced Narrow → AUTO.

The initial status is AUTO and the display shows these modes as follows.

- AUTO : FMA
- Forced Wide : FMW
- Forced Middle : FMM
- Forced Narrow : FMN

6. Test mode specifications of the CD receiver

- Forced ejection is inhibited in the reset start operation. When the unit is reset while a CD is loaded in it, the CD is not recognized by resetting.
- Each press of the Track Up key jumps to the following track numbers:
No. 9 → No. 15 → No. 10 → No. 11 → No. 12 → No. 13 → No. 14 → No. 9 (The cycle restarts from here.)
- Each press of the Track Down key jumps to the previous track number to the track being played.
- When the number of total tracks of the MP3 disc or the WMA disc is less than 9, 1st track is played.
- When the model is equipped the CD mechanism assembly adapted for MP3 or MP3/WMA disc, the mechanism name and version number are displayed during the CD source selecting.
- When the disc media is CD, A short press of the Preset 1 key jumps to the track number 28.

7. Audio-related specifications

- A short press of the Q key initiates the audio adjustment mode.
- Pressing the * key on the remote initiates the audio adjustment mode.
- Fader is selected to the initial item.
- Continuous holding of a remote control key is inhibited.
- Bass, Middle and Treble are adjusted in 3 steps of Min / Center / Max with the Track Up/Down keys.
- Balance is adjusted in 3 steps of Left Max / Center / Right Max with the Track Up/Down keys.
- Fader is adjusted in 3 steps of Rear Max / Center / Front Max with the Track Up/Down keys.
- HPF is adjusted in 2 steps of Through / 220Hz with the Track Up/Down keys.
- LPF is adjusted in 2 steps of Through / 120Hz with the Track Up/Down keys.
- Bass f, Bass Q, Bass EXT, Middle f, Middle Q and Treble f are not dealt with by the audio adjust.

8. Menu-related specifications

- Pressing the DNPP/SBF key on the remote initiates the Menu mode.
- Continuous holding of a remote control key is inhibited.
- In the case of the CD receiver model, A short press of the PLAY/PAUSE key initiates the Menu mode.

9. Backup current measurement

When the unit is reset while ACC is OFF (i.e. by turning Backup ON), the MUTE terminal goes OFF in 2 seconds in place of 15 second. (The CD mechanism is not activated at this time.)

10. Special display when the display is all on

Pressing the Preset keys while the power is ALL OFF displays the following information.

[PRESET 1]	Version display (8 digits, Month/Day/Hour/Minute) (Display)SYS xxxxxxxx : System microcomputer PAN xxxxxxxx : Panel microcomputer
[PRESET 2]	Sireal number display (8 digits) (Display) SNO xxxxxxxx
[PRESET 3]	Short press : View power ON time. (The All OFF period is not counted.) Long press/hold : Clear power ON time at the power ON time displaying. (Display) PonTim xxxxx Max. 65535 (hours)
[PRESET 4]	Short press : Display CD operation time. Long press/hold : Clear CD operation time at the CD operation time displaying. (Display) CDTime xxxxx Max. 65535 (hours)
[PRESET 5]	Short press : Display CD ejection count. Long press/hold : Clear CD ejection count at the CD ejection count displaying. (Display) EjeCnt xxxxx Max. 65535 (times)
[PRESET 6]	Short press : Display Panel open/close count. Long press/hold : Clear Panel open/close count at the Panel open/close count. (Display) PnCnt xxxxxx Max. 655350 (times)

TEST MODE

11. Method of the span switching (K and M type only)
While holding the Preset 1 and Preset 5 keys, reset the unit.
12. Other specifications
 - No displays such as "CODE OFF" during Power-ON.
 - Pressing the TI (AUTO) key during changer operation turns on 2zone. Cancel by pressing the TI (AUTO) key again. The P/S dot is lit during 2zone.
 - In the case of 2 PREOUT model with Non Fader output, Each pressing and holding the ATT key for 1 second or more during All OFF, Non Fader output is switching Rear output or Non Fader output.
 - In the case of 2 colors key illumination model, Each press the ATT key during All OFF, the key illumination is switching Green or Red.

• Security-related information

1. Forced Power ON mode (All models)
Even when the security (Cord) is approved, resetting the unit while holding the ATT and Preset 4 keys makes it possible to turn the power ON for 30 minutes.
After 30 minutes have elapsed, it is not possible to return to the previous condition unless the unit is reset again.
 2. Method of registration of the security code after EEPROM (Tuner Unit Ass'y) replacement (Code security model)
 1. Enter the test mode. (See 1. How to enter the test mode)
 2. Press the PLAY/PAUSE key to enter the Menu mode.
 3. When the message "Security" is displayed, press and hold the Track Up/Down key for 1 second to enter the security registration mode.
 4. Enter the code using the FM/AM/Track Up/Track Down keys.
 - FM key: Number up
 - AM key: Number down
 - Track Up key: Cursor right shift
 - Track Down key: Cursor left shift
 5. Hold down the Track Up key for at least 3 seconds and the message, "RE-ENTER" appears, so once again enter the code according to Step 4 above.
 6. Press and hold the Track Up key for 3 seconds until "APPROVED" is displayed.
 7. Exit from the test mode. (See 2. How to exit from the test mode)
(Note) All Clear is not applicable to the security code of this model.
3. Simple way to clear the security code (K type only)
 1. During code request mode, press the VOL UP key for at least 3 seconds while holding down the DISP key. (---- will disappear)
 2. Enter, "KCAR" with the remote controller as described below. (Same as on 01 model.)
 - Press the remote controller 5 key twice, and press the Track Up key. (Enters a "K")
 - Press the remote controller 2 key three times, and press the Track Up key. (Enters a "C")
 - Press the remote controller 2 key once, and press the Track Up key. (Enters an "A")
 - Press the remote controller 7 key twice, and press the Track Up key. (Enters an "R")
 3. Security function is canceled and unit sets to All-Off mode.
 4. Code request mode appears if a mistake was made in entering the numbers.

1

PC BOARD (COMPONENT SIDE VIEW) (FOIL SIDE VIEW)

2

X16-168X-XX (J74-1327-22)

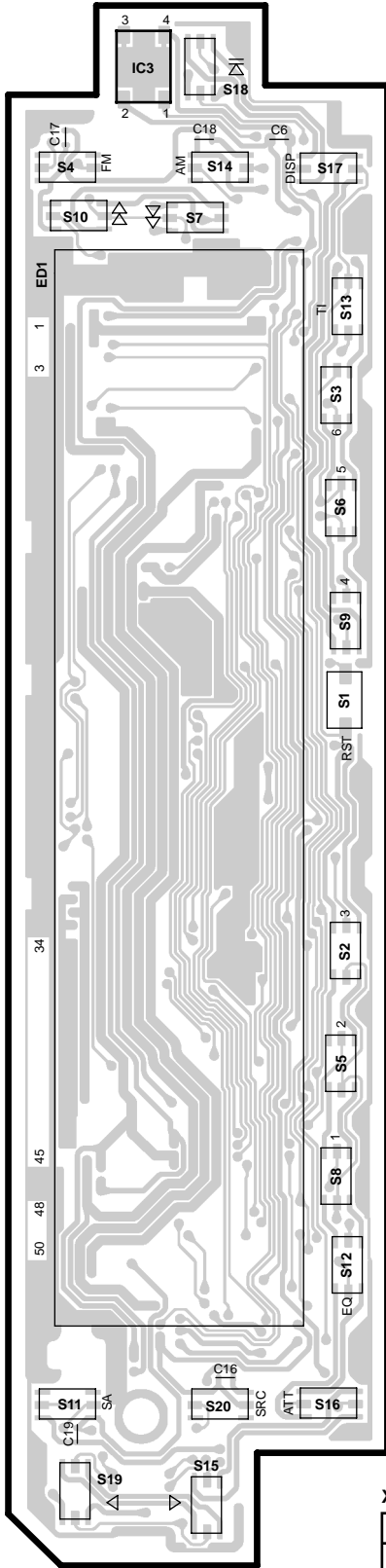

3

X16-168X-XX (J74-1327-22)

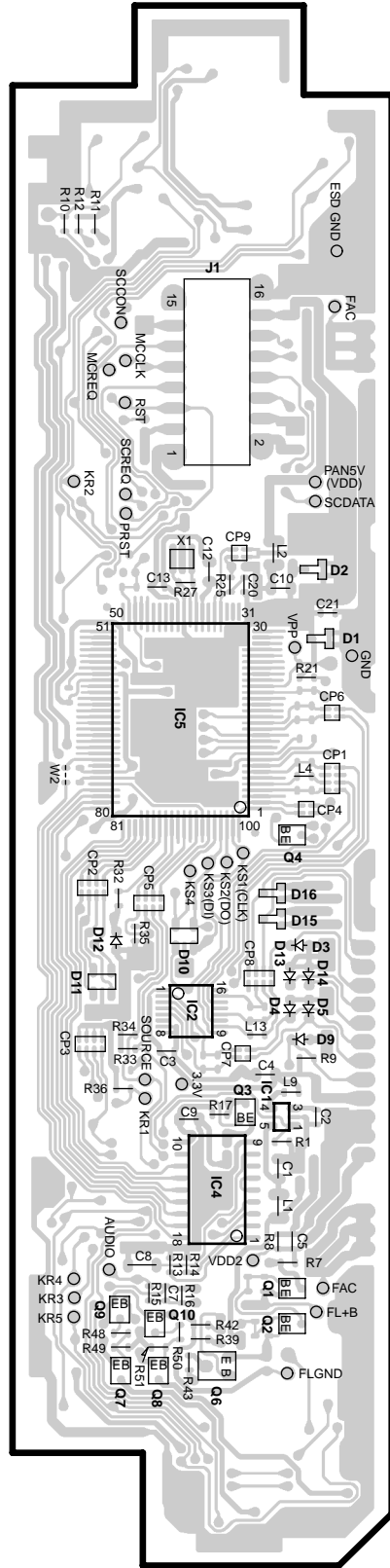

4

X16-168X-XX

IC	Q	Address
1		5D
2		5D
4		6D
5		4D
	1	6D
	2	6D
	3	5D
	4	4D
	6	6D
	7	6C
	8	6D
	9	6C
	10	6D

5

X16-168X-XX

IC	Q	Address
3		2B

6

7

PC BOARD (COMPONENT SIDE VIEW)

X25-924X-XX (J74-1328-22)

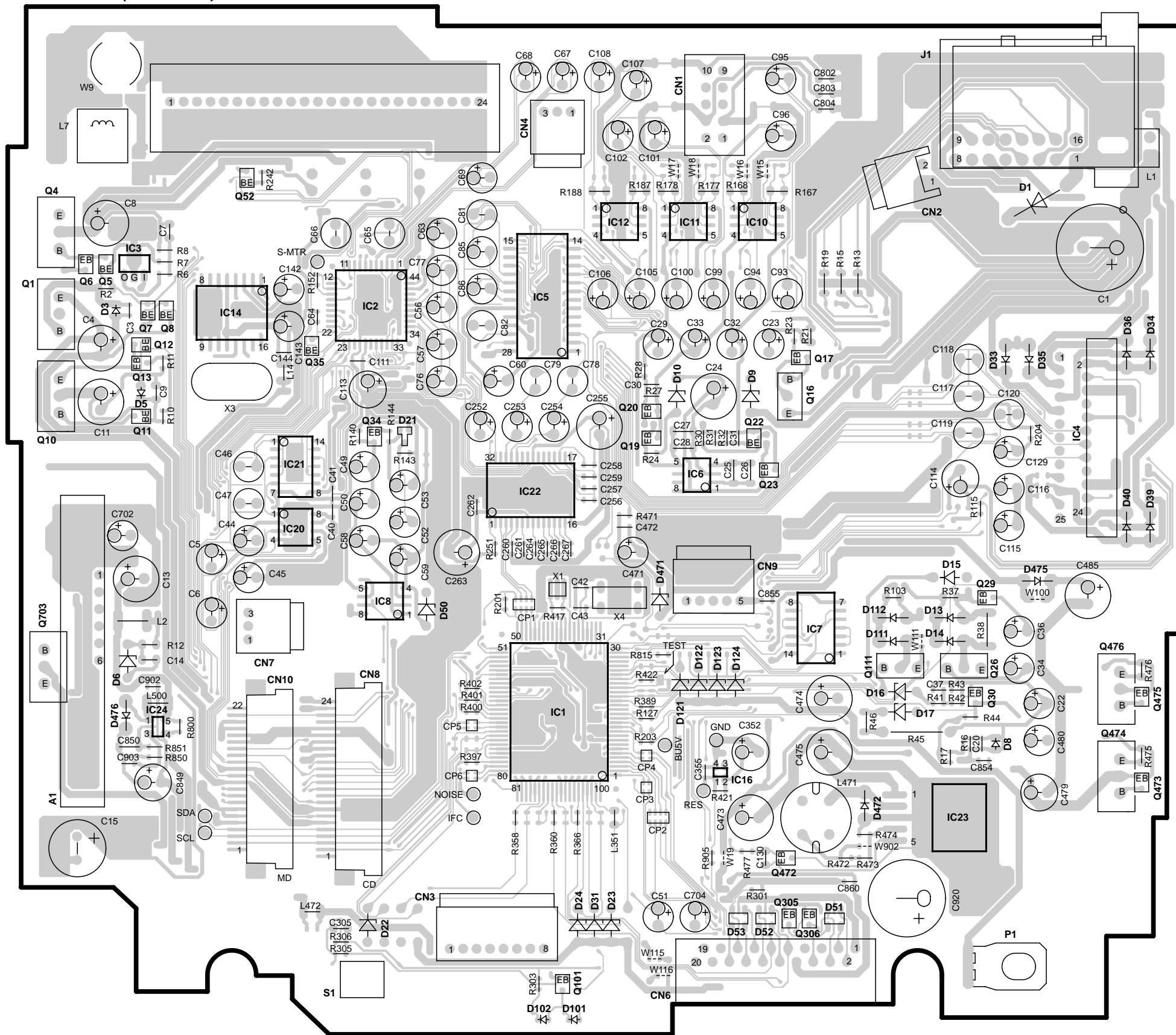

X89-253X-XX (J74-1332-12)

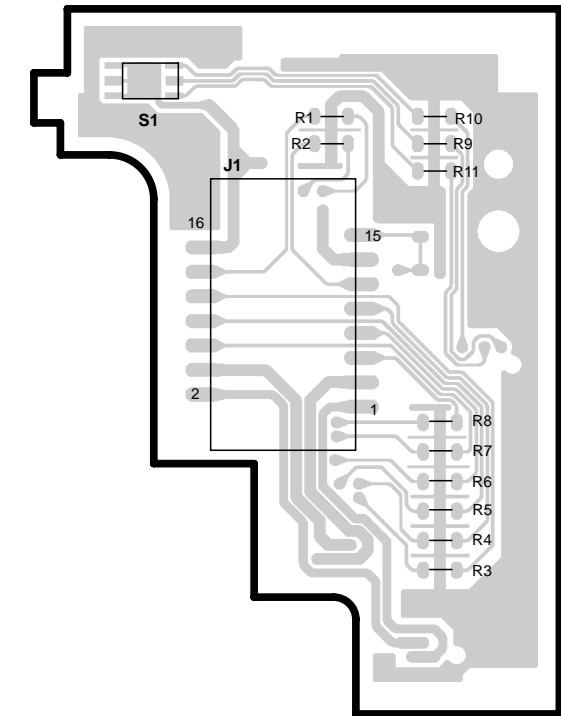

X25-924X-XX

IC	Q	Address	IC	Q	Address	IC	Q	Address	IC	Q	Address
1		5I	16	6J	13	3G	52	2G			
2		3H	20	4H	16	4K	101	7I			
3		3G	21	4H	17	3K	111	5K			
4		4L	1	3F	19	4J	305	6K			
5		3I	4	2F	20	4J	306	6K			
6		4J	5	3G	22	4J	473	6M			
7		5K	6	3G	23	4J	474	5L			
8		5H	7	3G	26	5L	475	5M			
10		3J	8	3G	29	5L	476	5L			
11		3J	10	4F	30	5L					
12		3J	11	4G	34	4H					
14		3G	12	3G	35	3H					

Refer to the schematic diagram for the values of resistors and capacitors.

PC BOARD (FOIL SIDE VIEW)

X25-924X-XX (J74-1328-22)

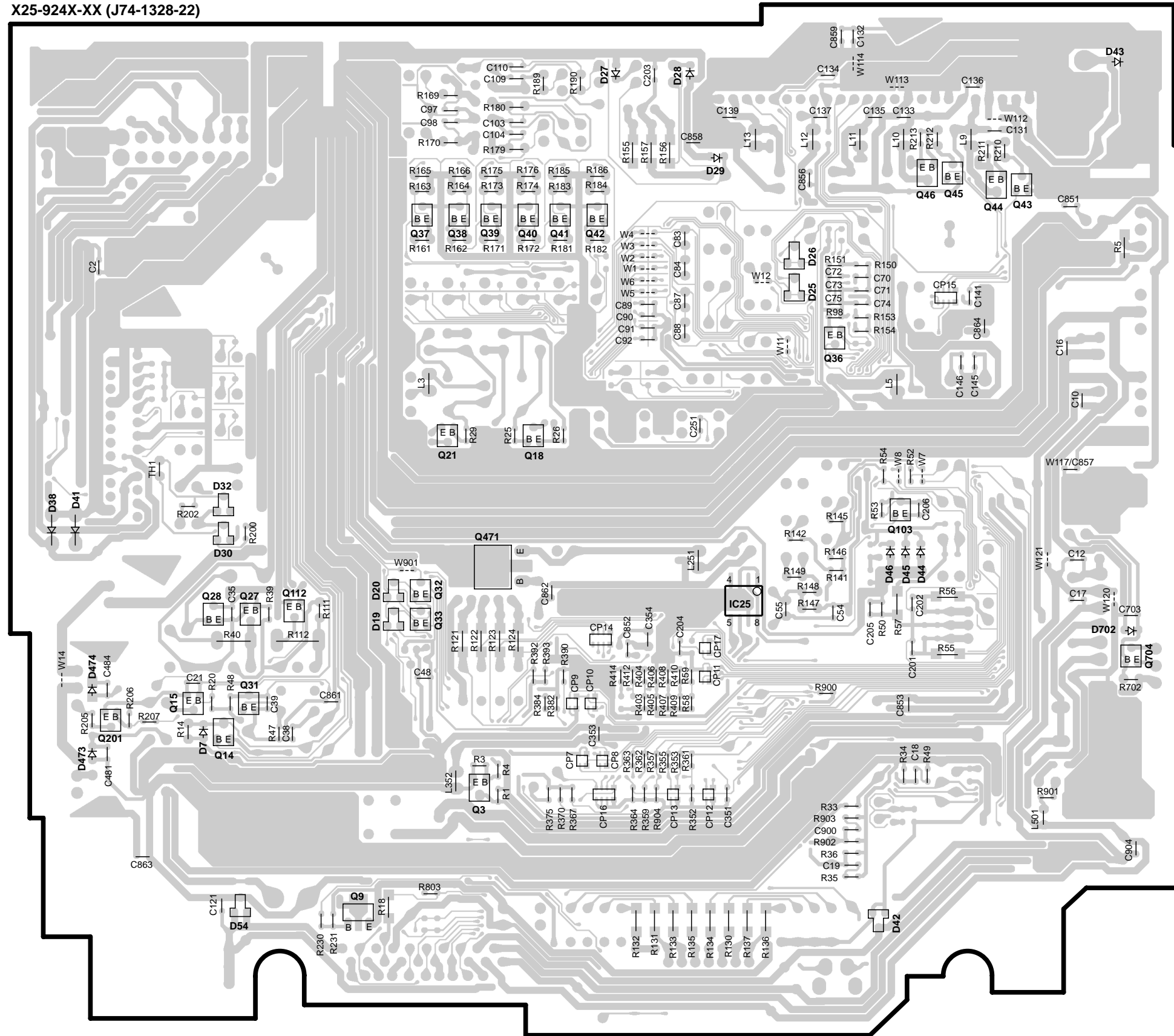

X89-253X-XX (J74-1332-12)

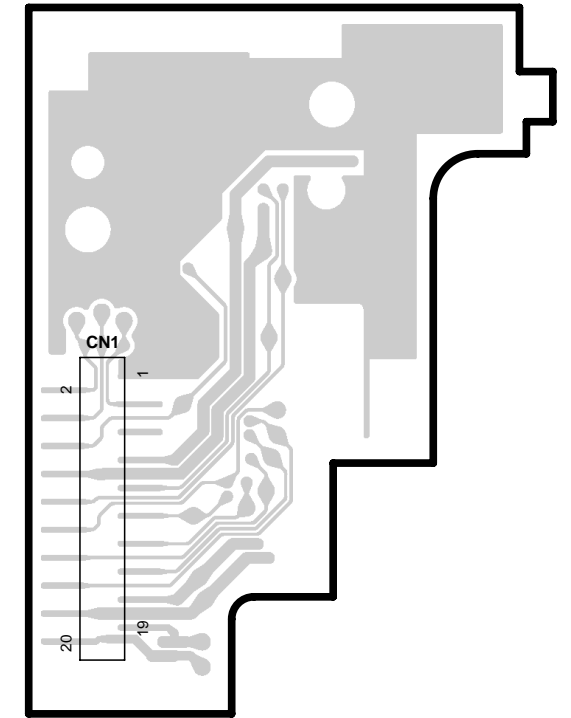

X25-924X-XX

IC	Q	Address	IC	Q	Address	IC	Q	Address
25	5T		31	5R		42	3S	
3	6S		32	4S		43	2V	
9	6R		33	5S		44	2V	
14	5Q		36	3U		45	2U	
15	5Q		37	3S		46	2U	
18	4S		38	3S		103	4U	
21	4S		39	3S		112	5R	
27	5R		40	3S		201	5Q	
28	5Q		41	3S				

Refer to the schematic diagram for the values of resistors and capacitors.

1

2

3

4

5

6

7

ELECTRIC UNIT (X25-924X-XX)

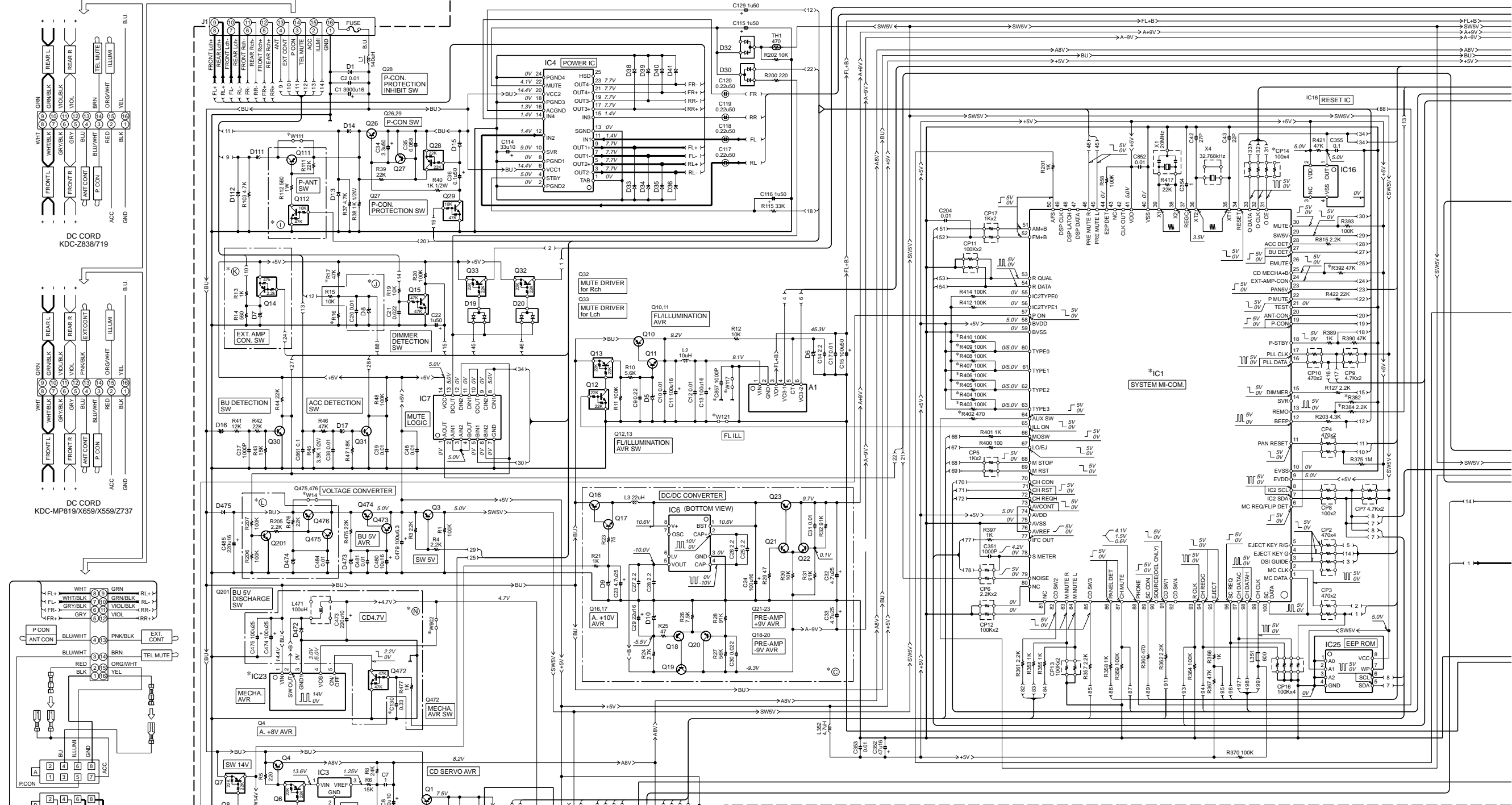

MODEL NAME	UNIT No.	A	B	C	D	E	F	G	H	I	J	K	L	N	C46	C47	C56,57	C58,59	C93,94	C130	C857	CP14	IC1	IC23	Q306	R16	R17	R163,164	R382	R392	R402	R403	R404	R405	R406	R407	R408	R409	R410	W16-6	W7	W11	W12	W14	W111	W121						
KDC-X559	K1-0-11	NO	YES	YES	YES	YES	YES	YES	NO	YES	YES	YES	YES	YES	YES	YES	YES	YES	YES	YES	YES	NO	NO	100K	NO	2.2K	100K	YES	YES	YES	NO	NO	NO	YES	NO	YES	YES	NO	NO	NO	NO	NO	NO	NO	NO	NO	NO	NO				
KDC-MP819	K3-0-12	NO	NO	YES	YES	NO	NO	YES	YES	NO	YES	YES	YES	NO	NO	NO	NO	NO	NO	NO	NO	NO	NO	100K	NO	2.2K	100K	YES	YES	YES	NO	NO	NO	NO	YES	NO	YES	NO	NO	NO	NO	NO	NO	NO	NO	NO	NO	NO	NO			
KDC-719	K2-0-13	NO	NO	NO	NO	YES	NO	NO	NO	NO	NO	NO	NO	NO	NO	NO	NO	NO	NO	NO	NO	NO	NO	100K	NO	2.2K	100K	NO	NO	NO	NO	NO	NO	NO	NO	YES	NO	NO	NO	NO	NO	NO	NO	NO	NO	NO	NO	NO	NO			
KDC-X559	K4-0-14	NO	YES	YES	YES	YES	NO	YES	YES	NO	YES	YES	YES	NO	NO	NO	NO	NO	NO	NO	NO	NO	NO	100K	NO	2.2K	100K	NO	YES	YES	NO	NO	NO	NO	NO	NO	NO	NO	NO	NO	NO	NO	NO	NO	NO	NO	NO	NO	NO	NO	NO	
KDC-Z838	M1-0-21	NO	YES	YES	YES	YES	NO	YES	YES	YES	YES	YES	YES	YES	YES	YES	YES	YES	YES	YES	YES	NO	NO	100K	NO	2.2K	100K	YES	YES	YES	NO	NO	NO	NO	NO	NO	NO	NO	NO	NO	NO	NO	NO	NO	NO	NO	NO	NO	NO	NO	NO	
KDC-Z737	M2-0-22	NO	NO	NO	NO	NO	NO	NO	NO	NO	NO	NO	NO	NO	NO	NO	NO	NO	NO	NO	NO	NO	NO	100K	NO	2.2K	100K	NO	YES	YES	NO	NO	NO	NO	NO	NO	NO	NO	NO	NO	NO	NO	NO	NO	NO	NO	NO	NO	NO	NO	NO	NO
Z638	E1-2-71	YES	NO	NO	NO	NO	NO	NO	NO	NO	NO	NO	NO	NO	NO	NO	NO	NO	NO	NO	NO	NO	NO	NO	NO	NO	NO	NO	NO	NO	NO	NO	NO	NO	NO	NO	NO	NO	NO	NO	NO	NO	NO	NO	NO	NO	NO	NO	NO	NO	NO	

to CD MECHA

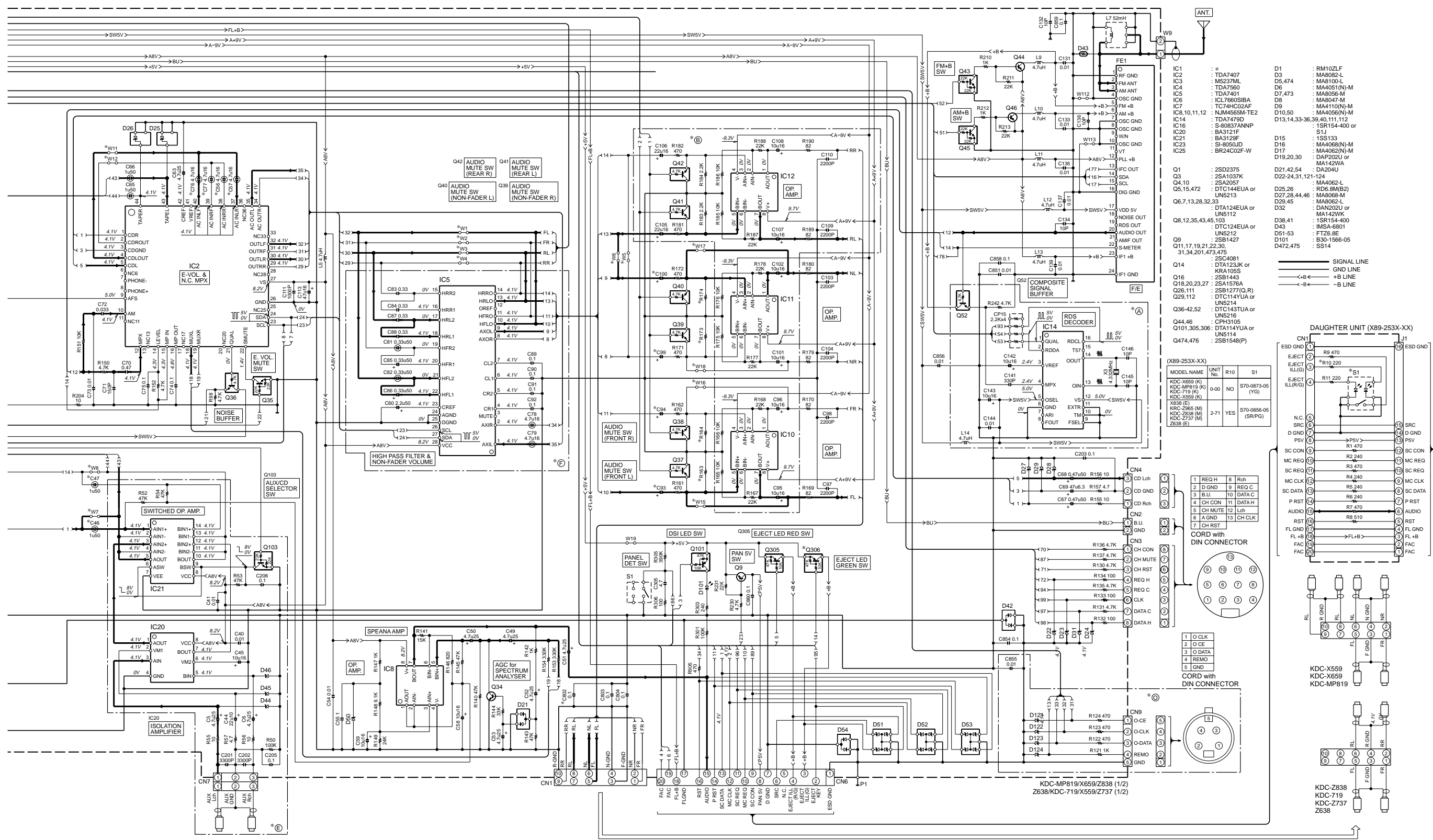

CAUTION : For continued safety, replace safety critical components only with manufacturer's recommended parts (refer to parts list).
 ⚠ Indicates safety critical components. To reduce the risk of electric shock, leakage-current or resistance measurements shall be carried out (exposed parts are acceptably insulated from the supply circuit) before the appliance is returned to the customer.
 • DC voltages are as measured with a high impedance voltmeter. Values may vary slightly due to variations between individual instruments or/and units.

SWITCH UNIT (X16-168X-XX)

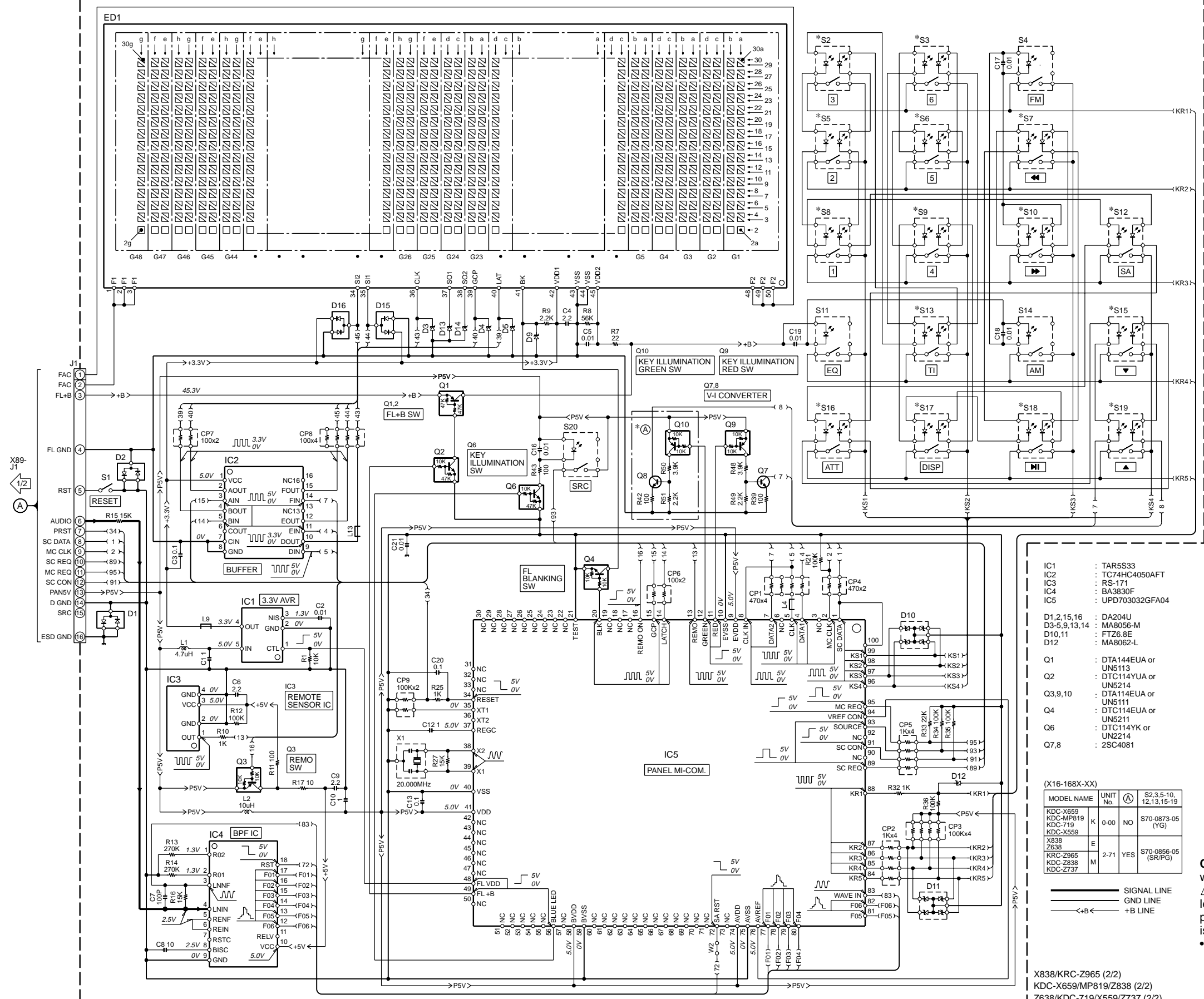

DTA123JK	UN5114		2SB1548		2SB1277
DTA144EUA	UN5211				2SB1443
DTC114YK	UN5213				
DTC114YUA	UN5214				
DTC143TUA	UN5216				
UN5111	2SA1576A				

2SA1037K	DTA114EUA	NJM4565M-TE2
2SC4081	DTA124EUA	
	DTC114EUA	
	DTC124EUA	
	DTC144EUA	

DAN202U	DAP202U	MA142WA
	DA204U	MA142WK
	DTA114YUA	UN5212

RD6.8M	TC74HC02AF	BA3129F

BA3830F	BA3121F	M5237ML

BR24C02F-W		TC74HC4050AFT
		TDA7479D

- IC1 : TAR5S33
 IC2 : TC74HC4050AFT
 IC3 : RS-171
 IC4 : BA3830F
 IC5 : UPD703032GFA04
- D1,2,15,16 : DA204U
 D3-5,9,13,14 : MA8056-M
 D10,11 : FTZ6.8E
 D12 : MA8062-L
- Q1 : DTA144EUA or UN5113
 Q2 : DTC114YUA or UN5214
 Q3,9,10 : DTA114EUA or UN5111
 Q4 : DTC114EUA or UN5211
 Q6 : DTC114YK or UN2214
 Q7,8 : 2SC4081

(X16-168X-XX)

MODEL NAME	UNIT No.	(A)	S2,3,5-10, 12,13,15-19
KDC-X659			
KDC-MP819	K	NO	S70-0873-05 (YG)
KDC-719			
KDC-X559			
X838			
Z638	E	2-71	S70-0856-05 (SR/PG)
KRC-Z965			
KDC-Z838			
KDC-Z737	M		

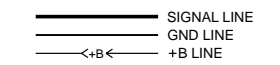

X838/KRC-Z965 (2/2)
 KDC-X659/MP819/Z838 (2/2)
 Z638/KDC-719/X559/Z737 (2/2)

CAUTION : For continued safety, replace safety critical components only with manufacturer's recommended parts (refer to parts list).
 ⚠ Indicates safety critical components. To reduce the risk of electric shock, leakage-current or resistance measurements shall be carried out (exposed parts are acceptably insulated from the supply circuit) before the appliance is returned to the customer.
 • DC voltages are as measured with a high impedance voltmeter. Values may vary slightly due to variations between individual instruments or/and units.

KDC-719/X559/Z737,Z638

KENWOOD

EXPLODED VIEW

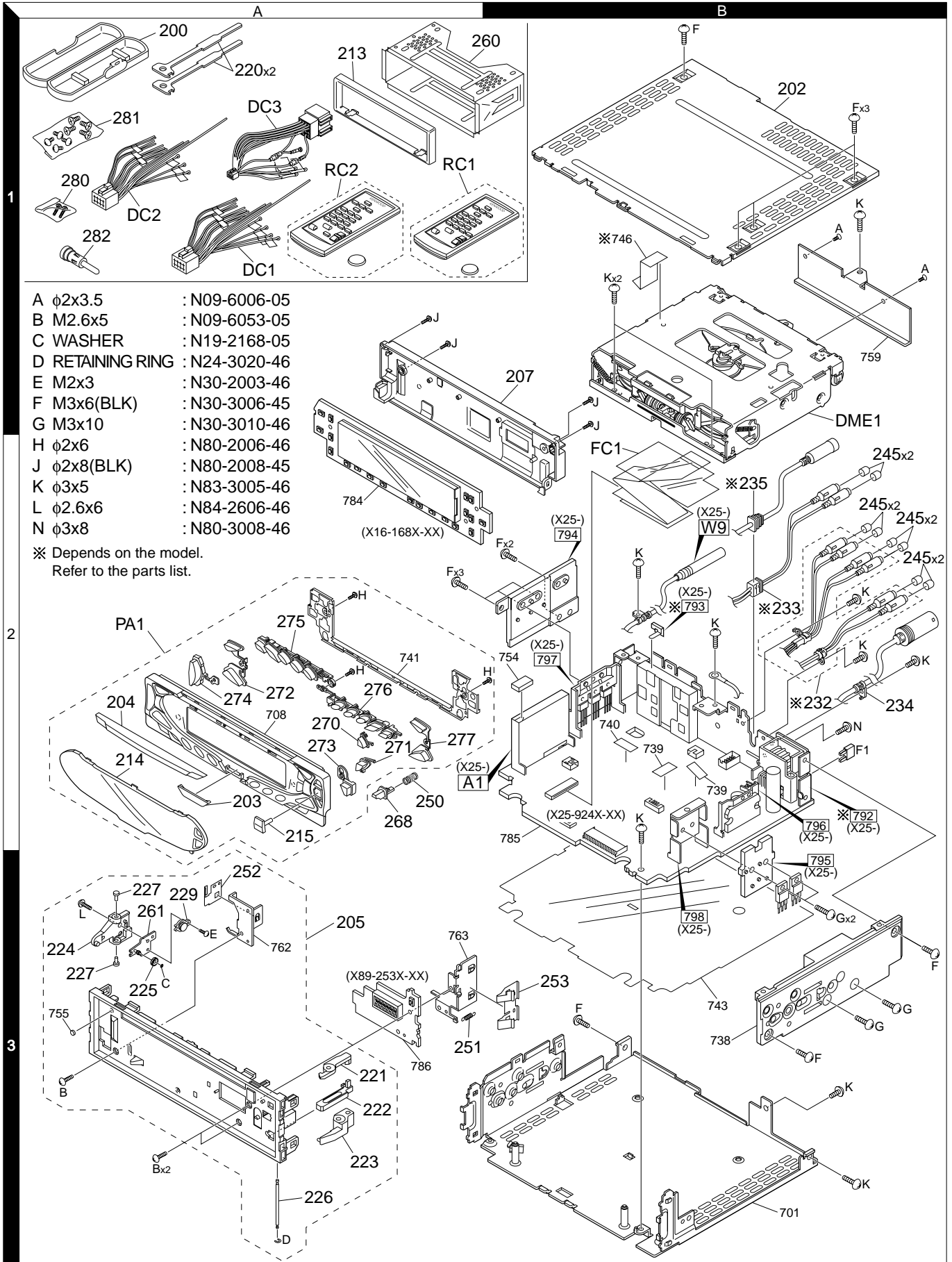

- A $\phi 2 \times 3.5$: N09-6006-05
- B M2.6x5 : N09-6053-05
- C WASHER : N19-2168-05
- D RETAINING RING : N24-3020-46
- E M2x3 : N30-2003-46
- F M3x6(BLK) : N30-3006-45
- G M3x10 : N30-3010-46
- H $\phi 2 \times 6$: N80-2006-46
- J $\phi 2 \times 8$ (BLK) : N80-2008-45
- K $\phi 3 \times 5$: N83-3005-46
- L $\phi 2.6 \times 6$: N84-2606-46
- N $\phi 3 \times 8$: N80-3008-46

※ Depends on the model.
Refer to the parts list.

Parts with the exploded numbers larger than 700 are not supplied.

PARTS LIST

* New parts

Parts without **Parts No.** are not supplied.Les articles non mentionnés dans le **Parts No.** ne sont pas fournis.Teile ohne **Parts No.** werden nicht geliefert.

Ref. No.	A d d	N e w	Parts No.	Description	Desti- nation	Ref. No.	A d d	N e w	Parts No.	Description	Desti- nation
KDC-719/X559/Z737,Z638											
200	1A	*	A02-2712-13	PLASTIC CABINET ASSY		F1	2B		F52-0006-05	FUSE (MINI BLADE TYPE) (10A)	
202	1B	*	A52-0811-12	TOP PLATE		F1	2B		F52-0011-05	FUSE (MINI BLADE TYPE) (10A)	
203	2A	*	A21-4175-04	DRESSING PANEL		250	2A	*	G01-3135-04	COMPRESSION SPRING	
204	2A	*	A21-4209-02	DRESSING PANEL	K2E1M2	251	3A	*	G01-3136-14	EXTENSION SPRING	
204	2A	*	A21-4210-02	DRESSING PANEL	K4	252	3A	*	G02-1428-04	FLAT SPRING	
						253	3B	*	G02-1429-04	FLAT SPRING	
205	3A	*	A22-2946-12	SUB PANEL ASSY		-		*	H10-4802-12	POLYSTYRENE FOAMED FIXTURE	
207	1B	*	A46-1756-11	REAR COVER		-		*	H25-0329-04	PROTECTION BAG (280X450X0.03)	K2K4M2
PA1	2A	*	A64-2646-11	PANEL ASSY	K2	-		*	H25-0337-04	PROTECTION BAG (180X300X0.03)	
PA1	2A	*	A64-2647-11	PANEL ASSY	E1	-		*	H25-1111-04	PROTECTION BAG (280X450X0.03)	E1
PA1	2A	*	A64-2648-11	PANEL ASSY	M2	-		*	H54-2320-03	ITEM CARTON CASE	K2
PA1	2A	*	A64-2650-11	PANEL ASSY	K4	-		*	H54-2321-03	ITEM CARTON CASE	E1
RC1	1A	*	A70-2025-05	REMOTE CONTROLLER ASSY (RC-410)	K2K4	-		*	H54-2322-03	ITEM CARTON CASE	M2
RC2	1A	*	A70-2026-05	REMOTE CONTROLLER ASSY (RC-420)	E1M2	-		*	H54-2324-03	ITEM CARTON CASE	K4
213	1A	*	B07-3050-02	ESCUTCHEON	K2E1M2	260	1A	*	J21-9823-03	MOUNTING HARDWARE ASSY	
213	1A	*	B07-3057-02	ESCUTCHEON	K4	261	3A	*	J21-9831-04	MOUNTING HARDWARE ASSY	
214	2A	*	B10-4209-01	FRONT GLASS	K2	268	2A	*	K24-3837-04	KNOB (OPEN)	
214	2A	*	B10-4210-01	FRONT GLASS	E1	270	2A	*	K24-3850-04	KNOB (SKIP UP)	K2E1M2
214	2A	*	B10-4211-01	FRONT GLASS	M2	270	2A	*	K24-3852-04	KNOB (SKIP UP)	K4
214	2A	*	B10-4213-01	FRONT GLASS	K4	271	2A	*	K24-3851-04	KNOB (SKIP DOWN)	K2E1M2
215	2A	*	B10-4217-04	FRONT GLASS		271	2A	*	K24-3853-04	KNOB (SKIP DOWN)	K4
-			B46-0100-50	WARRANTY CARD		272	2A	*	K25-1417-13	KNOB (EQ, SRC)	
-			B46-0606-04	ID CARD	K2K4	273	2A	*	K25-1418-03	KNOB (PAUSE)	
-			B46-0612-14	ID CARD	E1M2	274	2A	*	K25-1423-03	KNOB (VOL)	
-			B46-0645-03	USER CARD	K2K4	275	2A	*	K25-1428-03	KNOB (PRE1-3, ATT, Q)	K4
-			B46-0648-03	USER CARD	K4	275	2A	*	K25-1456-03	KNOB (PRE1-3)	K2E1M2
-			B58-1365-04	CAUTION CARD		276	2A	*	K25-1420-03	KNOB (PRE4-6, TI, DISP)	E1
-	*		B64-2176-00	INST. MANUAL (ENGLISH)	K2K4	276	2A	*	K25-1429-03	KNOB (PRE4-6, AUTO, DISP)	K4
-	*		B64-2177-00	INST. MANUAL (FRE, SPA)	K2K4	276	2A	*	K25-1457-03	KNOB (PRE4-6)	K2M2
-	*		B64-2178-00	INST. MANUAL (ENG, F-CHI)	M2	277	2A	*	K25-1458-13	KNOB (FM, AM)	K4
-	*		B64-2180-00	INST. MANUAL (ENGLISH)	E1	277	2A	*	K25-1459-13	KNOB (FM, AM)	K2E1M2
-	*		B64-2181-00	INST. MANUAL (FRE, GER)	E1	280	1A		N99-1656-05	SCREW SET	
-	*		B64-2182-00	INST. MANUAL (DUT, ITA) E1		281	1A		N99-1723-05	SCREW SET	
-	*		B64-2183-00	INST. MANUAL (SPA, POR)	E1	A	1B		N09-6006-05	TAPTITE SCREW (PAN ST 2X3.5T)	K2K4M2
220	1A	*	D10-4674-04	LEVER		B	3A	*	N09-6053-05	MACHINE SCREW (M2.6X5)	
221	3A	*	D10-4675-04	LEVER		C	3A	*	N19-2168-05	FLAT WASHER (1.4X3.0X0.25)	
222	3A	*	D10-4676-04	LEVER		D	3A		N24-3020-46	E TYPE RETAINING RING (2X5X1.7)	
223	3A	*	D10-4677-04	LEVER		E	3A		N30-2003-46	PAN HEAD MACHINE SCREW	
224	3A	*	D10-4678-03	LEVER		F	1B		N30-3006-45	PAN HEAD MACHINE SCREW	
225	3A	*	D13-2242-04	GEAR		G	3B		N30-3010-46	PAN HEAD MACHINE SCREW	
226	3A	*	D21-2406-04	SHAFT		H	2A		N80-2006-46	PAN HEAD TAPTITE SCREW	
227	3A	*	D21-2407-04	SHAFT		J	1A		N80-2008-45	PAN HEAD TAPTITE SCREW	
229	3A		D39-0237-05	DAMPER		K	1B		N83-3005-46	PAN HEAD TAPTITE SCREW	
232	2B	*	E30-6064-05	CORD WITH PINPLUG (6P)	K4	L	3A		N84-2606-46	PAN HEAD TAPTITE SCREW	
232	2B	*	E30-6065-05	CORD WITH PINPLUG (4P)	K2E1M2	282	1A		T90-0523-05	ANTENNA ADAPTOR	E1
233	2B	*	E30-6067-15	CORD WITH PINPLUG (AUX 2P)	K4M2	282	1A		T90-0534-05	ANTENNA ADAPTOR	E1
234	2B	*	E30-6068-05	CORD WITH DIN CONNECTOR (13P)		282	1A	*	T90-0552-05	ANTENNA ADAPTOR	E1
235	2B	*	E30-6069-05	CORD WITH DIN CONNECTOR (4P)	E1	DME1	1B	*	X92-4450-01	MECHANISM ASSY (DXM-6111W)	
△ DC1	1A	*	E30-6062-05	DC CORD	K4M2	SWITCH UNIT (X16-168x-xx)					
△ DC2	1A	*	E30-6106-05	DC CORD	K2	C1			CK73FB1A105K	CHIP C 1.0UF	K
△ DC3	1A	*	E30-6063-05	DC CORD	E1	C2			CK73GB1H103K	CHIP C 0.010UF	K
FC1	2B	*	E39-0447-05	FLAT CABLE (24P)		C3			CK73GB1C104K	CHIP C 0.10UF	K
245	2B		F29-0049-05	INSULATING COVER							

K2 : KDC-719 K4 : KDC-X559 M2 : KDC-Z737 E1 : Z638

△ Indicates safety critical components.

PARTS LIST

* New parts

Parts without **Parts No.** are not supplied.

Les articles non mentionnes dans le **Parts No.** ne sont pas fournis.

Teile ohne **Parts No.** werden nicht geliefert.

SWITCH UNIT (X16-168x-xx)

Ref. No.	A d d	N e w	Parts No.	Description	Desti- nation	Ref. No.	A d d	N e w	Parts No.	Description	Desti- nation
C4			CK73FB1A225K	CHIP C 2.2UF K		S2,3			S70-0856-05	TACT SWITCH	E1M2
C5			CK73GB1H103K	CHIP C 0.010UF K		S2,3			S70-0873-05	TACT SWITCH	K2K4
C6			CK73FB1A225K	CHIP C 2.2UF K		S4			S70-0857-05	TACT SWITCH	
C7			CC73GCH1H101J	CHIP C 100PF J		S5-10			S70-0856-05	TACT SWITCH	E1M2
C8			CK73EB0J106K	CHIP C 10UF K		S5-10			S70-0873-05	TACT SWITCH	K2K4
C9			CK73FB1A225K	CHIP C 2.2UF K		S11			S70-0857-05	TACT SWITCH	
C10			CK73FB1A105K	CHIP C 1.0UF K		S12,13			S70-0856-05	TACT SWITCH	E1M2
C12			CK73FB1A105K	CHIP C 1.0UF K		S12,13			S70-0873-05	TACT SWITCH	K2K4
C13			CK73GB1C104K	CHIP C 0.10UF K		S14			S70-0857-05	TACT SWITCH	
C16-19			CK73GB1H103K	CHIP C 0.010UF K		S15-19			S70-0856-05	TACT SWITCH	E1M2
C20			CK73GB1H104K	CHIP C 0.10UF K		S15-19			S70-0873-05	TACT SWITCH	K2K4
C21			CK73GB1H103K	CHIP C 0.010UF K		S20			S70-0857-05	TACT SWITCH	
J1			E59-0829-05	RECTANGULAR PLUG (16P)		D1,2			DA204U	DIODE	
L1			L40-4795-68	SMALL FIXED INDUCTOR (4.7UH)		D3-5			MA8056-M	ZENER DIODE	
L2		*	L40-1005-68	SMALL FIXED INDUCTOR (10UH)		D9			MA8056-M	ZENER DIODE	
L4			L92-0332-05	CHIP FERRITE		D10,11			FTZ6.8E	ZENER DIODE	
L9			L92-0332-05	CHIP FERRITE		D12			MA8062-L	ZENER DIODE	
L13			L92-0332-05	CHIP FERRITE		D13,14			MA8056-M	ZENER DIODE	
X1			L78-0821-05	RESONATOR (20.0MHZ)		D15,16			DA204U	DIODE	
CP1			R90-1016-05	MULTI-COMP 470 X4		ED1		*	CN2034M	FLUORESCENT INDICATOR TUBE	
CP2			R90-0724-05	MULTI-COMP 1K X4		IC1		*	TAR5S33	ANALOGUE IC	
CP3			R90-0720-05	MULTI-COMP 100K X4		IC2			TC74HC4050AFT	MOS-IC	
CP4			R90-1022-05	MULTI-COMP 470 X2		IC3			RS-171	ANALOGUE IC	
CP5			R90-0724-05	MULTI-COMP 1K X4		IC4			BA3830F	ANALOGUE IC	
CP6,7			R90-1019-05	MULTI-COMP 100 X2		IC5		*	UPD703032GFA04	MI-COM IC	
CP8			R90-1014-05	MULTI-COMP 100 X4		Q1			DTA144EUA	DIGITAL TRANSISTOR	
CP9			R90-0737-05	MULTI-COMP 100K X2		Q1			UN5113	DIGITAL TRANSISTOR	
R1			RK73GB2A103J	CHIP R 10K J 1/10W		Q2			DTC114YUA	DIGITAL TRANSISTOR	
R7		*	RK73GB2A220J	CHIP R 22 J 1/10W		Q2			UN5214	DIGITAL TRANSISTOR	
R8			RK73GB2A563J	CHIP R 56K J 1/10W		Q3			DTA114EUA	DIGITAL TRANSISTOR	
R9			RK73GB2A222J	CHIP R 2.2K J 1/10W		Q3			UN5111	DIGITAL TRANSISTOR	
R10			RK73GB2A102J	CHIP R 1.0K J 1/10W		Q4			DTC114EUA	DIGITAL TRANSISTOR	
R11			RK73GB2A101J	CHIP R 100 J 1/10W		Q4			UN5211	DIGITAL TRANSISTOR	
R12			RK73GB2A104J	CHIP R 100K J 1/10W		Q6			DTC114YK	DIGITAL TRANSISTOR	
R13,14		*	RK73GB2A274J	CHIP R 270K J 1/10W		Q6			UN2214	DIGITAL TRANSISTOR	
R15,16			RK73GB2A153J	CHIP R 15K J 1/10W		Q7			2SC4081	TRANSISTOR	E1M2
R17			RK73GB2A100J	CHIP R 10 J 1/10W		Q8			2SC4081	TRANSISTOR	
R21			RK73GB2A104J	CHIP R 100K J 1/10W		Q9			DTA114EUA	DIGITAL TRANSISTOR	K2K4
R25			RK73GB2A102J	CHIP R 1.0K J 1/10W		Q9			UN5111	DIGITAL TRANSISTOR	K2K4
R27			RK73GB2A153J	CHIP R 15K J 1/10W		Q9,10			DTA114EUA	DIGITAL TRANSISTOR	E1M2
R32			RK73GB2A102J	CHIP R 1.0K J 1/10W		Q9,10			UN5111	DIGITAL TRANSISTOR	E1M2
R33			RK73GB2A223J	CHIP R 22K J 1/10W		ELECTRIC UNIT (X25-924x-xx)					
R34-36			RK73GB2A104J	CHIP R 100K J 1/10W		D101			B30-1566-05	LED (1608,RED)	
R39			RK73GB2A101J	CHIP R 100 J 1/10W		C1			C90-2822-05	ELECTRO 3900UF 16WV	K2E1M2
R42			RK73GB2A101J	CHIP R 100 J 1/10W	E1M2	C1			C90-5377-05	ELECTRO 3900UF 16WV	K4
R43			RK73GB2A101J	CHIP R 100 J 1/10W		C2			CK73GB1H103K	CHIP C 0.010UF K	
R48			RK73GB2A392J	CHIP R 3.9K J 1/10W		C3			CK73GB1C104K	CHIP C 0.10UF K	
R49			RK73GB2A222J	CHIP R 2.2K J 1/10W		C4		*	C90-5442-05	ELECTRO 100UF 10WV	
R50			RK73GB2A392J	CHIP R 3.9K J 1/10W	E1M2	C5,6			CE04NW1E4R7M	ELECTRO 4.7UF 25WV	K4M2
R51			RK73GB2A222J	CHIP R 2.2K J 1/10W	E1M2	C7			CK73FB1C105K	CHIP C 1.0UF K	
W2			R92-1252-05	CHIP R 0 OHM J 1/16W		C8			CE04DW1A221M	ELECTRO 220UF 10WV	
S1			S70-0863-05	TACT SWITCH		C9			CK73FB1C224K	CHIP C 0.22UF K	
						C10			CK73GB1H103K	CHIP C 0.010UF K	

K2 : KDC-719 K4 : KDC-X559 M2 : KDC-Z737 E1 : Z638

△ Indicates safety critical components.

PARTS LIST

* New parts

Parts without **Parts No.** are not supplied.Les articles non mentionnés dans le **Parts No.** ne sont pas fournis.Teile ohne **Parts No.** werden nicht geliefert.

ELECTRIC UNIT (X25-924x-xx)

Ref. No.	A d d	N e w	Parts No.	Description	Desti- nation	Ref. No.	A d d	N e w	Parts No.	Description	Desti- nation
C11			C90-2966-05	ELECTRO 100UF 16WV		C97,98			CK73GB1H222K	CHIP C 2200PF K	
C12			CK73GB1H103K	CHIP C 0.010UF K		C99,100			CE04NW1C100M	ELECTRO 10UF 16WV	K2E1M2
C13			C90-2966-05	ELECTRO 100UF 16WV		C99,100			CE04NW1C220M	ELECTRO 22UF 16WV	K4
C14			CK73FB1A225K	CHIP C 2.2UF K		C101,102			CE04NW1C100M	ELECTRO 10UF 16WV	K4
C15			C90-2979-05	ELECTRO 100UF 50WV		C103,104			CK73GB1H222K	CHIP C 2200PF K	
C16			CK73GB1C104K	CHIP C 0.10UF K		C105,106			CE04NW1C220M	ELECTRO 22UF 16WV	K4
C17			CK73GB1H103K	CHIP C 0.010UF K		C107,108			CE04NW1C100M	ELECTRO 10UF 16WV	K4
C19			CK73GB1H103K	CHIP C 0.010UF K		C109,110			CK73GB1H222K	CHIP C 2200PF K	K4
C20			CK73GB1H103K	CHIP C 0.010UF K	E1	C111			CK73GB1H102K	CHIP C 1000PF K	
C21			CK73GB1E223K	CHIP C 0.022UF K		C113			CE04NW1C470M	ELECTRO 47UF 16WV	
C22			C90-2558-05	ELECTRO 1.0UF 50WV		C114			C90-2551-05	ELECTRO 33UF 10WV	
C23			CE04NW1E4R7M	ELECTRO 4.7UF 25WV	K4	C115,116			C90-2558-05	ELECTRO 1.0UF 50WV	
C24			C90-2966-05	ELECTRO 100UF 16WV	K4	C117-120			C90-5297-05	NP-ELEC 0.22UF 50WV	
C25-28			CK73EB1C225K	CHIP C 2.2UF K	K4	C129			C90-5308-05	ELECTRO 1.0UF 50WV	
C29			CE04NW1C220M	ELECTRO 22UF 16WV	K4	C131			CK73GB1H103K	CHIP C 0.010UF K	
C30			CK73GB1E223K	CHIP C 0.022UF K	K4	C132			CC73GCH1H100D	CHIP C 10PF D	
C31			CK73GB1H103K	CHIP C 0.010UF K	K4	C133			CK73GB1H103K	CHIP C 0.010UF K	
C32,33			CE04NW1E4R7M	ELECTRO 4.7UF 25WV	K4	C134			CC73GCH1H100D	CHIP C 10PF D	
C34			C90-2556-05	ELECTRO 3.3UF 50WV		C135			CK73GB1H103K	CHIP C 0.010UF K	
C35			CK73GB1C683K	CHIP C 0.068UF K		C136			CC73GCH1H100D	CHIP C 10PF D	
C36			C90-2562-05	ELECTRO 0.10UF 50WV		C137			CK73GB1H103K	CHIP C 0.010UF K	
C37			CK73GB1H102K	CHIP C 1000PF K		C139			CK73GB1H103K	CHIP C 0.010UF K	
C38,39			CK73GB1H103K	CHIP C 0.010UF K		C141			CK73GB1H331K	CHIP C 330PF K	E1
C40,41			CK73GB1H103K	CHIP C 0.010UF K	K4M2	C142,143	*		C90-5437-05	ELECTRO 10UF 16WV	E1
C42			CC73GCH1H270J	CHIP C 27PF J		C144			CK73GB1H103K	CHIP C 0.010UF K	E1
C43			CC73GCH1H220J	CHIP C 22PF J		C145,146			CC73GCH1H100D	CHIP C 10PF D	E1
C44			CE04NW1A220M	ELECTRO 22UF 10WV	K4M2	C201,202			CK73GB1H332K	CHIP C 3300PF K	K4M2
C45			CE04NW1C100M	ELECTRO 10UF 16WV	K4M2	C203			CK73GB1H104K	CHIP C 0.10UF K	
C46,47			C90-2658-05	NP-ELEC 1.0UF 50WV	K4M2	C204			CK73GB1H103K	CHIP C 0.010UF K	
C48			CK73GB1H103K	CHIP C 0.010UF K		C205			CK73GB1H104K	CHIP C 0.10UF K	K4M2
C49-53		*	C90-5444-05	ELECTRO 4.7UF 25WV		C206			CK73GB1C104K	CHIP C 0.10UF K	K4M2
C54			CK73GB1H103K	CHIP C 0.010UF K		C305			CK73FB0J475K	CHIP C 4.7UF K	
C55			CK73FB1C105K	CHIP C 1.0UF K		C351			CK73GB1H102K	CHIP C 1000PF K	
C56,57			C90-2524-05	NP-ELEC 4.7UF 16WV	K4	C352	*		C90-5443-05	ELECTRO 47UF 16WV	
C58			CE04NW1C100M	ELECTRO 10UF 16WV		C353			CK73GB1H103K	CHIP C 0.010UF K	
C59			CE04MW1C100M	ELECTRO 10UF 16WV		C354			CK73FB1C105K	CHIP C 1.0UF K	
C60			CE04NW1H2R2M	ELECTRO 2.2UF 50WV	K4	C355			CK73GB1C104K	CHIP C 0.10UF K	
C63		*	CE04NW1E4R7MEL	ELECTRO 4.7UF 25WV		C479			C90-2547-05	ELECTRO 100UF 6.3WV	
C65,66			C90-2658-05	NP-ELEC 1.0UF 50WV		C480			C90-2554-05	ELECTRO 10UF 16WV	
C67,68			CE04NW1HR47M	ELECTRO 0.47UF 50WV		C481			CK73GB1H103K	CHIP C 0.010UF K	
C69			CE04NW0J470M	ELECTRO 47UF 6.3WV		C484			CK73GB1H103K	CHIP C 0.010UF K	
C70			CK73GB1A474K	CHIP C 0.47UF K		C485			C90-2980-05	ELECTRO 220UF 16WV	
C71			CC73GCH1H151J	CHIP C 150PF J		C802			CK73FB1H104K	CHIP C 0.10UF K	K4
C72			CK73GB1E333K	CHIP C 0.033UF K		C803,804			CK73FB1H104K	CHIP C 0.10UF K	
C73			CK73GB1H103K	CHIP C 0.010UF K		C851,852			CK73GB1H103K	CHIP C 0.010UF K	
C74,75			CK73GB1C104K	CHIP C 0.10UF K		C853,854			CK73GB1H104K	CHIP C 0.10UF K	
C76-79			C90-2524-05	NP-ELEC 4.7UF 16WV	K4	C855			CK73GB1H103K	CHIP C 0.010UF K	E1
C81,82		*	C90-5429-05	NP-ELEC 0.33UF 50WV	K4	C856			CK73GB1H103K	CHIP C 0.010UF K	
C83,84			CK73FB1C334K	CHIP C 0.33UF K	K4	C857			CK73GB1H102K	CHIP C 1000PF K	K2K4M2
C85,86			CE04NW1HR33M	ELECTRO 0.33UF 50WV	K4	C858-861			CK73GB1H104K	CHIP C 0.10UF K	
C87,88			CK73FB1C334K	CHIP C 0.33UF K	K4	C900			CK73GB1H103K	CHIP C 0.010UF K	
C89-92			CK73GB1C104K	CHIP C 0.10UF K	K4	CN1	*		E41-0174-05	PIN ASSY (10P)	
C93,94			CE04NW1C100M	ELECTRO 10UF 16WV	K2E1M2	CN2			E40-3299-05	PIN ASSY (2P)	
C93,94			CE04NW1C220M	ELECTRO 22UF 16WV	K4	CN3			E40-3266-05	PIN ASSY (8P)	
C95,96			CE04NW1C100M	ELECTRO 10UF 16WV	K4						

K2 : KDC-719 K4 : KDC-X559 M2 : KDC-Z737 E1 : Z638

△ Indicates safety critical components.

PARTS LIST

* New parts

Parts without **Parts No.** are not supplied.

Les articles non mentionnes dans le **Parts No.** ne sont pas fournis.

Teile ohne **Parts No.** werden nicht geliefert.

ELECTRIC UNIT (X25-924x-xx)

Ref. No.	Add	New	Parts No.	Description	Destination	Ref. No.	Add	New	Parts No.	Description	Destination
CN4			E40-3261-05	PIN ASSY (3P)		R19			RK73EB2E103J	CHIP R 10K J 1/4W	
CN6			E40-9490-15	PIN ASSY (20P)		R20			RK73GB2A104J	CHIP R 100K J 1/10W	
CN7			E40-3261-05	PIN ASSY (3P)	K4M2	R21			RK73FB2B102J	CHIP R 1.0K J 1/8W	K4
CN8		*	E41-0194-05	FLAT CABLE CONNECTOR (24P)		R23		*	RK73GB2A750J	CHIP R 75 J 1/10W	K4
CN9			E40-3263-05	PIN ASSY (5P)	E1	R24			RK73GB2A272J	CHIP R 2.7K J 1/10W	K4
△ J1			E58-0863-15	RECTANGULAR RECEPTACLE (16P)		R25			RK73GB2A470J	CHIP R 47 J 1/10W	K4
W9	2B	*	E30-6098-05	CORD WITH PLUG		R26		*	RK73GB2A752J	CHIP R 7.5K J 1/10W	K4
L1			L33-1170-05	CHOKO COIL ASSY (140UH)		R27			RK73GB2A563J	CHIP R 56K J 1/10W	K4
L2			L33-1153-05	SMALL FIXED INDUCTOR (10UH)	K4	R28			RK73GB2A913J	CHIP R 91K J 1/10W	K4
L3			L40-2201-78	SMALL FIXED INDUCTOR (22UH)		R29			RK73GB2A470J	CHIP R 47 J 1/10W	K4
L5			L40-4792-78	SMALL FIXED INDUCTOR (4.7UH)		R30			RK73GB2A103J	CHIP R 10K J 1/10W	K4
L7			L33-1039-05	LINE FILTER COIL (52mH)		R31,32			RK73GB2A913J	CHIP R 91K J 1/10W	K4
L9-13			L40-4795-68	SMALL FIXED INDUCTOR (4.7UH)		R33			RK73GB2A472J	CHIP R 4.7K J 1/10W	
L14			L40-4795-68	SMALL FIXED INDUCTOR (4.7UH)	E1	R35			RK73GB2A471J	CHIP R 470 J 1/10W	
L351			L92-0075-05	CHIP FERRITE		R36			RK73GB2A104J	CHIP R 100K J 1/10W	
L352			L40-4792-78	SMALL FIXED INDUCTOR (4.7UH)		R37			RK73FB2B472J	CHIP R 4.7K J 1/8W	
X1			L78-0821-05	RESONATOR (20.0MHZ)		R38			R92-0365-05	CHIP R 1.0K J 1/2W	
X3			L77-2002-05	CRYSTAL RESONATOR (4.332MHZ)	E1	R39			RK73GB2A223J	CHIP R 22K J 1/10W	
X4			L77-2738-05	CRYSTAL RESONATOR (32.768KHZ)		R40			R92-0365-05	CHIP R 1.0K J 1/2W	
						R41			RK73GB2A123J	CHIP R 12K J 1/10W	
F	2B		N30-3006-45	PAN HEAD MACHINE SCREW		R42			RK73GB2A223J	CHIP R 22K J 1/10W	
G	3B		N30-3010-46	PAN HEAD MACHINE SCREW		R43			RK73GB2A153J	CHIP R 15K J 1/10W	
K	2B		N83-3005-46	PAN HEAD TAPTITE SCREW		R44			RK73GB2A223J	CHIP R 22K J 1/10W	
N	2B		N80-3008-46	PAN HEAD TAPTITE SCREW		R45			RD14DB2H332J	SMALL-RD 3.3K J 1/2W	
						R46			RK73EB2E473J	CHIP R 47K J 1/4W	
CP2			R90-1016-05	MULTI-COMP 470 X4		R47			RK73GB2A183J	CHIP R 18K J 1/10W	
CP3,4			R90-1022-05	MULTI-COMP 470 X2		R48			RK73GB2A104J	CHIP R 100K J 1/10W	
CP5			R90-0725-05	MULTI-COMP 1K X2		R50			RK73GB2A104J	CHIP R 100K J 1/10W	K4M2
CP6			R90-1013-05	MULTI-COMP 2.2K X2		R52-54			RK73GB2A473J	CHIP R 47K J 1/10W	K4M2
CP7		*	R90-1048-05	MULTI-COMP 4.7K X2		R55,56			RK73EB2E100J	CHIP R 10 J 1/4W	K4M2
CP8		*	R90-1508-05	MULTI-COMP 100 X2							
CP9		*	R90-1048-05	MULTI-COMP 4.7K X2		R57			RK73EB2E4R7J	CHIP R 4.7 J 1/4W	K4M2
CP10		*	R90-1045-05	MULTI-COMP 470 X2		R58			RK73GB2A104J	CHIP R 100K J 1/10W	
CP11-13		*	R90-1051-05	MULTI-COMP 100K X2		R98			RK73GB2A472J	CHIP R 4.7K J 1/10W	
CP14		*	R90-1509-05	MULTI-COMP 100 X4	E1	R103			RK73FB2B472J	CHIP R 4.7K J 1/8W	
CP15		*	R90-1054-05	MULTI-COMP 2.2K X4	E1	R111			RK73FB2B223J	CHIP R 22K J 1/8W	K2K4M2
CP16		*	R90-1058-05	MULTI-COMP 100K X4							
CP17			R90-1046-05	MULTI-COMP 1K X2		R112			R92-0366-05	CHIP R 560 J 1W	K2K4M2
R1			RK73GB2A104J	CHIP R 100K J 1/10W		R115			RK73GB2A333J	CHIP R 33K J 1/10W	
R2			RK73FB2B152J	CHIP R 1.5K J 1/8W		R121			RK73EB2E102J	CHIP R 1.0K J 1/4W	E1
R3			RK73GB2A223J	CHIP R 22K J 1/10W		R122-124			RK73EB2E471J	CHIP R 470 J 1/4W	E1
R4			RK73GB2A222J	CHIP R 2.2K J 1/10W		R127			RK73GB2A222J	CHIP R 2.2K J 1/10W	
R5			RK73EB2E221J	CHIP R 220 J 1/4W		R130,131			RK73EB2E472J	CHIP R 4.7K J 1/4W	
R6			RK73GB2A153J	CHIP R 15K J 1/10W		R132-134			RK73EB2E101J	CHIP R 100 J 1/4W	
R7			RK73GH1J432D	CHIP R 4.3K D 1/16W		R135-137			RK73EB2E472J	CHIP R 4.7K J 1/4W	
R8			RK73GH1J243D	CHIP R 24K D 1/16W		R140			RK73GB2A473J	CHIP R 47K J 1/10W	
R10			RK73GB2A562J	CHIP R 5.6K J 1/10W		R141			RK73GB2A153J	CHIP R 15K J 1/10W	
R11			RK73GB2A104J	CHIP R 100K J 1/10W		R142			RK73GB2A102J	CHIP R 1.0K J 1/10W	
R12			RK73FB2B103J	CHIP R 10K J 1/8W		R143			RK73GB2A473J	CHIP R 47K J 1/10W	
R13			RK73EB2E102J	CHIP R 1.0K J 1/4W	K4E1M2	R144			RK73GB2A333J	CHIP R 33K J 1/10W	
R14			RK73FB2B561J	CHIP R 560 J 1/8W	K4E1M2	R145			RK73GB2A473J	CHIP R 47K J 1/10W	
R15			RK73EB2E103J	CHIP R 10K J 1/4W	E1	R146		*	RK73GB2A821J	CHIP R 820 J 1/10W	
R16			RK73GB2A104J	CHIP R 100K J 1/10W	K2K4M2	R147			RK73FB2B102J	CHIP R 1.0K J 1/8W	
R16			RK73GB2A223J	CHIP R 22K J 1/10W	E1	R148			RK73FB2B912J	CHIP R 9.1K J 1/8W	
R17			RK73GB2A473J	CHIP R 47K J 1/10W	E1	R149			RK73FB2B243J	CHIP R 24K J 1/8W	
						R150			RK73GB2A472J	CHIP R 4.7K J 1/10W	
						R151			RK73GB2A103J	CHIP R 10K J 1/10W	

K2 : KDC-719 K4 : KDC-X559 M2 : KDC-Z737 E1 : Z638

△ Indicates safety critical components.

PARTS LIST

* New parts

Parts without **Parts No.** are not supplied.Les articles non mentionnés dans le **Parts No.** ne sont pas fournis.Teile ohne **Parts No.** werden nicht geliefert.

ELECTRIC UNIT (X25-924x-xx)

Ref. No.	A d d	N e w	Parts No.	Description	Desti- nation	Ref. No.	A d d	N e w	Parts No.	Description	Desti- nation
R152			RK73GB2A472J	CHIP R 4.7K J 1/10W		R390			RK73GB2A473J	CHIP R 47K J 1/10W	
R153,154			RK73GB2A334J	CHIP R 330K J 1/10W		R393			RK73GB2A104J	CHIP R 100K J 1/10W	
R155,156			RK73EB2E100J	CHIP R 10 J 1/4W		R397			RK73GB2A102J	CHIP R 1.0K J 1/10W	
R157			RK73EB2E4R7J	CHIP R 4.7 J 1/4W		R400			RK73GB2A101J	CHIP R 100 J 1/10W	
R161,162			RK73FB2B471J	CHIP R 470 J 1/8W		R401			RK73GB2A102J	CHIP R 1.0K J 1/10W	
R163,164			RK73FB2B222J	CHIP R 2.2K J 1/8W	K4	R402			RK73GB2A471J	CHIP R 470 J 1/10W	K4M2
R163,164			RK73FB2B223J	CHIP R 22K J 1/8W	K2E1M2	R403			RK73GB2A104J	CHIP R 100K J 1/10W	K2K4M2
R165,166			RK73FB2B103J	CHIP R 10K J 1/8W	K4	R404			RK73GB2A104J	CHIP R 100K J 1/10W	E1
R167,168			RK73FB2B223J	CHIP R 22K J 1/8W	K4	R405			RK73GB2A104J	CHIP R 100K J 1/10W	K2K4
R169,170		*	RK73FB2B820J	CHIP R 82 J 1/8W		R406			RK73GB2A104J	CHIP R 100K J 1/10W	E1M2
R171,172			RK73FB2B471J	CHIP R 470 J 1/8W		R407			RK73GB2A104J	CHIP R 100K J 1/10W	K4E1M2
R173,174			RK73FB2B222J	CHIP R 2.2K J 1/8W	K4	R408			RK73GB2A104J	CHIP R 100K J 1/10W	K2
R173,174			RK73FB2B223J	CHIP R 22K J 1/8W	K2E1M2	R409			RK73GB2A104J	CHIP R 100K J 1/10W	
R175,176			RK73FB2B103J	CHIP R 10K J 1/8W	K4	R412			RK73GB2A104J	CHIP R 100K J 1/10W	
R177,178			RK73FB2B223J	CHIP R 22K J 1/8W	K4	R414			RK73GB2A104J	CHIP R 100K J 1/10W	
R179,180		*	RK73FB2B820J	CHIP R 82 J 1/8W		R417			RK73GB2A223J	CHIP R 22K J 1/10W	
R181,182			RK73FB2B471J	CHIP R 470 J 1/8W	K4	R421			RK73GB2A473J	CHIP R 47K J 1/10W	
R183,184			RK73FB2B222J	CHIP R 2.2K J 1/8W	K4	R422			RK73GB2A223J	CHIP R 22K J 1/10W	
R185,186			RK73FB2B103J	CHIP R 10K J 1/8W	K4	R475,476			RK73FB2B223J	CHIP R 22K J 1/8W	
R187,188			RK73FB2B223J	CHIP R 22K J 1/8W	K4	R815			RK73GB2A222J	CHIP R 2.2K J 1/10W	
R189,190		*	RK73FB2B820J	CHIP R 82 J 1/8W	K4	R902			RK73GB2A104J	CHIP R 100K J 1/10W	
R200			RK73GB2A221J	CHIP R 220 J 1/10W		R903			RK73GB2A471J	CHIP R 470 J 1/10W	
R201			RK73GB2A102J	CHIP R 1.0K J 1/10W		R905			RK73GB2A471J	CHIP R 470 J 1/10W	
R202			RK73GB2A103J	CHIP R 10K J 1/10W		W1-6			R92-1252-05	CHIP R 0 OHM J 1/16W	K2E1M2
R203			RK73GB2A432J	CHIP R 4.3K J 1/10W		W7,8			R92-1252-05	CHIP R 0 OHM J 1/16W	K2E1
R204			RK73GB2A100J	CHIP R 10 J 1/10W		W11,12			R92-1252-05	CHIP R 0 OHM J 1/16W	K4
R205			RK73GB2A222J	CHIP R 2.2K J 1/10W		W15-18			R92-1252-05	CHIP R 0 OHM J 1/16W	K2E1M2
R206,207			RK73GB2A104J	CHIP R 100K J 1/10W		W19			R92-1252-05	CHIP R 0 OHM J 1/16W	
R210			RK73FB2B102J	CHIP R 1.0K J 1/8W		W111			R92-1252-05	CHIP R 0 OHM J 1/16W	E1
R211			RK73GB2A223J	CHIP R 22K J 1/10W		W112,113			R92-1252-05	CHIP R 0 OHM J 1/16W	
R212			RK73FB2B102J	CHIP R 1.0K J 1/8W		W117			R92-1252-05	CHIP R 0 OHM J 1/16W	E1
R213			RK73GB2A223J	CHIP R 22K J 1/10W		W120			R92-1252-05	CHIP R 0 OHM J 1/16W	
R230			RK73GB2A472J	CHIP R 4.7K J 1/10W		W121			R92-1252-05	CHIP R 0 OHM J 1/16W	K2K4M2
R231			RK73GB2A223J	CHIP R 22K J 1/10W		S1			S74-0809-05	MICRO SWITCH	
R242			RK73GB2A472J	CHIP R 4.7K J 1/10W	E1	D1			RM10ZLF	DIODE	
R301		*	RK73GB2A104J	CHIP R 100K J 1/10W		D3		*	MA8082-L	ZENER DIODE	
R303			RK73GB2A241J	CHIP R 240 J 1/10W		D5		*	MA8100-L	ZENER DIODE	
R305			RK73GB2A394J	CHIP R 390K J 1/10W		D6			MA4051(N)-M	ZENER DIODE	
R306			RK73GB2A101J	CHIP R 100 J 1/10W		D7			MA8056-M	ZENER DIODE	K4E1M2
R353			RK73GB2A102J	CHIP R 1.0K J 1/10W		D8			MA8047-M	ZENER DIODE	E1
R355			RK73GB2A102J	CHIP R 1.0K J 1/10W		D9			MA4110(N)-M	ZENER DIODE	K4
R357			RK73GB2A222J	CHIP R 2.2K J 1/10W		D10			MA4056(N)-M	ZENER DIODE	K4
R358			RK73GB2A102J	CHIP R 1.0K J 1/10W		D13,14			S1J	DIODE	
R359			RK73GB2A104J	CHIP R 100K J 1/10W		D13,14			1SR154-400	DIODE	
R360			RK73GB2A471J	CHIP R 470 J 1/10W		D15			1SS133	DIODE	
R361,362			RK73GB2A222J	CHIP R 2.2K J 1/10W		D16			MA4068(N)-M	ZENER DIODE	
R364			RK73GB2A104J	CHIP R 100K J 1/10W		D17			MA4062(N)-M	ZENER DIODE	
R366			RK73GB2A102J	CHIP R 1.0K J 1/10W		D19,20			DAP202U	DIODE	
R367			RK73GB2A473J	CHIP R 47K J 1/10W		D19,20			MA142WA	DIODE	
R370			RK73GB2A104J	CHIP R 100K J 1/10W		D21			DA204U	DIODE	
R375			RK73GB2A105J	CHIP R 1.0M J 1/10W		D22-24			MA4062-L	ZENER DIODE	
R382			RK73GB2A104J	CHIP R 100K J 1/10W	K2K4M2	D25,26			RD6.8M(B2)	ZENER DIODE	
R382			RK73GB2A225J	CHIP R 2.2M J 1/10W	E1	D27,28			MA8068-M	ZENER DIODE	
R384			RK73GB2A222J	CHIP R 2.2K J 1/10W	E1	D29			MA8062-L	ZENER DIODE	
R389			RK73GB2A102J	CHIP R 1.0K J 1/10W							

PARTS LIST

* New parts

Parts without **Parts No.** are not supplied.

Les articles non mentionnes dans le **Parts No.** ne sont pas fournis.

Teile ohne **Parts No.** werden nicht geliefert.

ELECTRIC UNIT (X25-924x-xx)

Ref. No.	A d d	N e w	Parts No.	Description	Desti- nation	Ref. No.	A d d	N e w	Parts No.	Description	Desti- nation
D30			DAP202U	DIODE		Q15			DTC144EUA	DIGITAL TRANSISTOR	
D30			MA142WA	DIODE		Q15			UN5213	DIGITAL TRANSISTOR	
D31			MA4062-L	ZENER DIODE		Q16			2SB1443	TRANSISTOR	K4
D32			DAN202U	DIODE		Q17			2SC4081	TRANSISTOR	K4
D32			MA142WK	DIODE		Q18			2SA1576A	TRANSISTOR	K4
D33-36			S1J	DIODE		Q19			2SC4081	TRANSISTOR	K4
D33-36			1SR154-400	DIODE		Q20			2SA1576A	TRANSISTOR	K4
D38-41			1SR154-400	DIODE		Q21,22			2SC4081	TRANSISTOR	K4
D39,40			S1J	DIODE		Q23			2SA1576A	TRANSISTOR	K4
D42			DA204U	DIODE		Q26			2SB1277(Q,R)	TRANSISTOR	
D43			IMSA-6801	SURGE ABSORBER		Q27			2SA1576A	TRANSISTOR	
D44			MA8068-M	ZENER DIODE	K4M2	Q28			DTA124EUA	DIGITAL TRANSISTOR	
D45			MA8062-L	ZENER DIODE	K4M2	Q28			UN5112	DIGITAL TRANSISTOR	
D46			MA8068-M	ZENER DIODE	K4M2	Q29			DTC114YUA	DIGITAL TRANSISTOR	
D50			MA4056(N)-M	ZENER DIODE		Q29			UN5214	DIGITAL TRANSISTOR	
D51-53			FTZ6.8E	ZENER DIODE		Q30,31			2SC4081	TRANSISTOR	
D54			DA204U	DIODE		Q32,33			DTA124EUA	DIGITAL TRANSISTOR	
D111,112			S1J	DIODE		Q32,33			UN5112	DIGITAL TRANSISTOR	
D111,112			1SR154-400	DIODE		Q34			2SC4081	TRANSISTOR	
D121-124			MA4062-L	ZENER DIODE	E1	Q35			DTC124EUA	DIGITAL TRANSISTOR	
D473			MA8056-M	ZENER DIODE		Q35			UN5212	DIGITAL TRANSISTOR	
D474		*	MA8100-L	ZENER DIODE		Q36-40			DTC143TUA	DIGITAL TRANSISTOR	
D475			SS14	DIODE		Q36-40			UN5216	DIGITAL TRANSISTOR	
IC1			UPD703033GFA18	MI-COM IC		Q41,42			DTC143TUA	DIGITAL TRANSISTOR	K4
IC2			TDA7407	ANALOGUE IC		Q41,42			UN5216	DIGITAL TRANSISTOR	K4
IC3			M5237ML	IC(VOLTAGE REGULATOR)		Q43			DTC124EUA	DIGITAL TRANSISTOR	
IC4			TDA7560	ANALOGUE IC		Q43			UN5212	DIGITAL TRANSISTOR	
IC5			TDA7401	ANALOGUE IC	K4	Q44			CPH3105	TRANSISTOR	
IC6			ICL7660SIBA	ANALOGUE IC	K4	Q45			DTC124EUA	DIGITAL TRANSISTOR	
IC7			TC74HC02AF	MOS-IC		Q45			UN5212	DIGITAL TRANSISTOR	
IC8			NJM4565M-TE2	ANALOGUE IC		Q46			CPH3105	TRANSISTOR	
IC10-12			NJM4565M-TE2	ANALOGUE IC	K4	Q52			DTC143TUA	DIGITAL TRANSISTOR	E1
IC14			TDA7479D	ANALOGUE IC	E1	Q52			UN5216	DIGITAL TRANSISTOR	E1
IC16			S-80837ANNP	MOS-IC		Q101			DTA114YUA	DIGITAL TRANSISTOR	
IC20			BA3121F	IC (ISO AMP)	K4M2	Q101			UN5114	DIGITAL TRANSISTOR	
IC21			BA3129F	IC (SWITCH)	K4M2	Q103			DTC124EUA	DIGITAL TRANSISTOR	K4M2
IC25			BR24C02F-W	MEMORY IC		Q103			UN5212	DIGITAL TRANSISTOR	K4M2
Q1			2SD2375	TRANSISTOR		Q111			2SB1277(Q,R)	TRANSISTOR	K2K4M2
Q3			2SA1037K	TRANSISTOR		Q112			DTC114YUA	DIGITAL TRANSISTOR	K2K4M2
Q4			2SA2057	TRANSISTOR		Q112			UN5214	DIGITAL TRANSISTOR	K2K4M2
Q5			DTC144EUA	DIGITAL TRANSISTOR		Q201			2SC4081	TRANSISTOR	
Q5			UN5213	DIGITAL TRANSISTOR		Q305			DTA114YUA	DIGITAL TRANSISTOR	
Q6,7			DTA124EUA	DIGITAL TRANSISTOR		Q305			UN5114	DIGITAL TRANSISTOR	
Q6,7			UN5112	DIGITAL TRANSISTOR		Q306			DTA114YUA	DIGITAL TRANSISTOR	E1M2
Q8			DTC124EUA	DIGITAL TRANSISTOR		Q306			UN5114	DIGITAL TRANSISTOR	E1M2
Q8			UN5212	DIGITAL TRANSISTOR		Q473			2SC4081	TRANSISTOR	
Q9			2SB1427	TRANSISTOR		Q474			2SB1548(P)	TRANSISTOR	
Q10			2SA2057	TRANSISTOR		Q475			2SC4081	TRANSISTOR	
Q11			2SC4081	TRANSISTOR		Q476			2SB1548(P)	TRANSISTOR	
Q12			DTC124EUA	DIGITAL TRANSISTOR		TH1			PTH9C42BD471Q	POSITIVE RESISTOR	
Q12			UN5212	DIGITAL TRANSISTOR		A1	2A	*	W02-3341-05	ELECTRIC CIRCUIT MODULE	
Q13			DTA124EUA	DIGITAL TRANSISTOR		FE1		*	X86-3530-11	TUNER UNIT	K2K4M2
Q13			UN5112	DIGITAL TRANSISTOR		FE1		*	X86-3532-70	TUNER UNIT	E1
Q14			DTA123JK	DIGITAL TRANSISTOR	K4E1M2						
Q14			KRA105S	DIGITAL TRANSISTOR	K4E1M2						

K2 : KDC-719 K4 : KDC-X559 M2 : KDC-Z737 E1 : Z638

△ Indicates safety critical components.

PARTS LIST

* New parts
 Parts without **Parts No.** are not supplied.
 Les articles non mentionnes dans le **Parts No.** ne sont pas fournis.
 Teile ohne **Parts No.** werden nicht geliefert.

Ref. No.	A d d	N e w	Parts No.	Description	Desti- nation
DAUGHTER UNIT (X89-253x-xx)					
CN1			E40-9488-05	SOCKET FOR PIN ASSY (20P)	
J1			E58-0865-05	RECTANGULAR RECEPTACLE (16P)	
R1			RK73EB2E471J	CHIP R 470 J 1/4W	
R2			RK73EB2E241J	CHIP R 240 J 1/4W	
R3			RK73EB2E471J	CHIP R 470 J 1/4W	
R4-6			RK73EB2E241J	CHIP R 240 J 1/4W	
R7			RK73EB2E471J	CHIP R 470 J 1/4W	
R8			RK73EB2E511J	CHIP R 510 J 1/4W	
R9			RK73EB2E471J	CHIP R 470 J 1/4W	
R10			RK73EB2E221J	CHIP R 220 J 1/4W	E1M2
R11			RK73EB2E221J	CHIP R 220 J 1/4W	E1M2
S1			S70-0856-05	TACT SWITCH	E1M2
S1			S70-0873-05	TACT SWITCH	K2K4

Ref. No.	A d d	N e w	Parts No.	Description	Desti- nation
----------	-------------	-------------	-----------	-------------	------------------

SPECIFICATIONS

		KDC-Z737 (M)	Z638 (E)
FM	Frequency Range (Frequency step)	87.5MHz - 108.0MHz (50kHz) 87.9MHz - 107.9MHz (200kHz)	87.5MHz-108.0MHz (50kHz)
	Channel Space Selection	50k/200kHz	-
	Usable Sensitivity (S/N 26dB)	-	0.7μV/75Ω
	Usable Sensitivity (S/N 30dB)	9.3dBf (0.8μV/75Ω)	-
	Quieting Sensitivity (S/N 46dB)	-	1.6μV/75Ω
	Quieting Sensitivity (S/N 50dB)	15.2dBf (1.6μV/75Ω)	-
	Frequency Response (±3.0dB)	30Hz - 15kHz	30Hz - 15kHz
	S/N	70dB (MONO)	65dB (MONO)
	Selectivity(DIN)	-	≥80dB (±400kHz)
	Selectivity	≥80dB (±400kHz)	-
Stereo Separation	40dB (1kHz)	35dB (1kHz)	
AM (MW)	Frequency Range (Frequency step)	531kHz - 1611kHz (9kHz) 530kHz - 1700kHz (10kHz)	531kHz - 1611kHz (9kHz)
	Channel Space Selection	9k/10kHz	-
	Usable Sensitivity (S/N 20dB)	28dBμ (25μV)	25μV
LW	Frequency Range	-	153kHz - 281kHz
	Usable Sensitivity (S/N 20dB)	-	45μV
CD	Laser Diode	GaAlAs (λ=780nm)	GaAlAs (λ=780nm)
	Digital Filter (D/A)	8 Times Over Sampling	8 Times Over Sampling
	D/A Converter	1 Bit	1 Bit
	Spindle Speed	500~200rpm (CLV)	500~200rpm (CLV)
	Wow & Flutter	Below Measurable Limit	Below Measurable Limit
	Frequency Response	10Hz - 20kHz (±1dB)	10Hz - 20kHz (±1dB)
	Total Harmonic Distortion	0.01% (1kHz)	0.01% (1kHz)
	S/N Ratio	93dB (1kHz)	93dB (1kHz)
	Dynamic Range	93dB	93dB
	Channel Separation	85dB	85dB
Preout	Level/Load -Unbalanced	1800mV/10kΩ (CD/CD-CH)	1800mV/10kΩ (CD/CD-CH)
	Impedance	≤600	≤600Ω
AUX input	Frequency Response	20Hz - 20kHz (±1dB)	-
	Maximum input level	1.2V	-
	Input impedance	≥44kΩ	-
AMP	Maximum Power	50Wx4	50Wx4
	Power (DIN45324, +B=14.4V)	-	30Wx4
	Full Bandwidth Power (at less than 1%THD)	22Wx4	-
TONE	Bass	100Hz ±10dB	100Hz ±10dB
	Middle	1kHz ±10dB	1kHz ±10dB
	Treble	10kHz ±10dB	10kHz ±10dB
GENERAL	Operating Voltage (11V~16V allowable)	14.4V	14.4V
	Current Consumption	10A	10A
	Installation Size (W)	180 (mm)	180 (mm)
	(H)	50 (mm)	50 (mm)
	(D)	159 (mm)	159 (mm)
	Weight	1.4kg	1.4kg

SPECIFICATIONS

		KDC-719 (K)	KDC-X559 (K)	
FM	Frequency Range (Frequency step)	87.9MHz - 107.9MHz (200kHz)	87.9MHz - 107.9MHz (200kHz)	
	Channel Space Selection	50k/200kHz	50k/200kHz	
	Usable Sensitivity (S/N 30dB)	9.3dBf (0.8μV/75Ω)	9.3dBf (0.8μV/75Ω)	
	Quieting Sensitivity (S/N 50dB)	15.2dBf (1.6μV/75Ω)	15.2dBf (1.6μV/75Ω)	
	Frequency Response (±3.0dB)	30Hz - 15kHz	30Hz - 15kHz	
	S/N	70dB (MONO)	70dB (MONO)	
	Selectivity	≥80dB (±400kHz)	≥80dB (±400kHz)	
	Stereo Separation	40dB (1kHz)	40dB (1kHz)	
AM	Frequency Range (Frequency step)	530kHz - 1700kHz (10kHz)	530kHz - 1700kHz (10kHz)	
	Channel Space Selection	9k/10kHz	9k/10kHz	
	Usable Sensitivity (S/N 20dB)	28dBμ (25μV)	28dBμ (25μV)	
CD	Laser Diode	GaAlAs (λ=780nm)	GaAlAs (λ=780nm)	
	Digital Filter (D/A)	8 Times Over Sampling	8 Times Over Sampling	
	D/A Converter	1 Bit	1 Bit	
	Spindle Speed	500~200rpm (CLV)	500~200rpm (CLV)	
	Wow & Flutter	Below Measurable Limit	Below Measurable Limit	
	Frequency Response	10Hz - 20kHz (±1dB)	10Hz - 20kHz (±1dB)	
	Total Harmonic Distortion	0.01% (1kHz)	0.01% (1kHz)	
	S/N Ratio	93dB (1kHz)	93dB (1kHz)	
	Dynamic Range	93dB	93dB	
	Channel Separation	85dB	85dB	
Preout	Level/Load -Unbalanced	1800mV/10kΩ (CD/CD-CH)	4500mV/10kΩ (CD/CD-CH)	
	Impedance	≤600Ω	≤80Ω	
AUX input	Frequency Response	-	20Hz - 20kHz (±1dB)	
	Maximum input level	-	1.2V	
	Input impedance	-	≥44kΩ	
AMP	Maximum Power	50Wx4	50Wx4	
	Full Bandwidth Power (at less than 1%THD)	22Wx4	22Wx4	
TONE	Bass	100Hz ±10dB	100Hz ±10dB	
	Middle	1kHz ±10dB	1kHz ±10dB	
	Treble	10kHz ±10dB	10kHz ±10dB	
GENERAL	Operating Voltage (11V~16V allowable)	14.4V	14.4V	
	Current Consumption	10A	10A	
	Installation Size (W)	180 (mm) 7-1/16 (in.)	180 (mm) 7-1/16 (in.)	
		(H)	50 (mm) 1-15/16 (in.)	50 (mm) 1-15/16 (in.)
		(D)	159 (mm) 6-1/4 (in.)	159 (mm) 6-1/4 (in.)
Weight	1.4kg (3.08 lbs.)	1.4kg (3.08 lbs.)		

KENWOOD follows a policy of continuous advancements in development. For this reason specifications may be changed without notice.

KENWOOD CORPORATION

14-6, Dogenzaka 1-chome, Shibuya-ku, Tokyo 150-8501 Japan

KENWOOD SERVICE CORPORATION
P.O. BOX 22745, 2201 East Dominguez Street, Long Beach, CA90801-5745, U.S.A.

KENWOOD ELECTRONICS CANADA INC.
6070 Kestrel Road, Mississauga, Ontario, Canada L5T 1S8

KENWOOD ELECTRONICS LATIN AMERICA S.A.
P.O. Box 55-2791 Paitilla, Plaza Credicorp Bank Panama,
Piso 9, Oficina 901, Calle 50, Panama, Rep. de Panama

KENWOOD ELECTRONICS BRASIL LTDA.
Alameda Ministro Rocha Azevedo No. 456,
Edifício Jaú, 10o Andar, Cerqueira César, Cep 0140-001,
São Paulo-SP-Brasil

KENWOOD ELECTRONICS UK LIMITED
Kenwood House, Dwight Road, Watford, Herts, WD1 8EB, United Kingdom

KENWOOD ELECTRONICS DEUTSCHLAND GMBH
Rembrücker-Str. 15, 63150 Heusenstamm, Germany

KENWOOD ELECTRONICS FRANCE S.A.
13, Boulevard Ney, 75018 Paris, France

KENWOOD ELECTRONICS BELGIUM N.V.
Leuvensesteenweg 248 J, 1800 Vilvoorde, Belgium

KENWOOD ELECTRONICS ITALIA S.p.A.
Via G. Sirtori 7/9, 20129 Milano, Italy

KENWOOD IBÉRICA S.A.
Bolivia, 239-08020 Barcelona, Spain

KENWOOD ELECTRONICS AUSTRALIA PTY. LTD. (A.C.N. 001 499 074)
16 Giffnock Avenue, Centrecourt Estate, North Ryde,
N.S.W. 2113, Australia

KENWOOD ELECTRONICS (HONG KONG) LTD.
Unit 3712-3724, Level 37, Tower 1, Metroplaza, 223 Hing Fong Road, Kwai Fong, N.T.,
Hong Kong

KENWOOD ELECTRONICS GULF FZE
P.O. Box 61318, Jebel Ali, Dubai, U.A.E.

KENWOOD ELECTRONICS (THAILAND) CO., LTD.
2019 New Pechburi Road, Bangkapi, Huaykwang, Bangkok, 10320 Thailand

KENWOOD ELECTRONICS SINGAPORE PTE. LTD.
1 Genting Lane, #07-00, Kenwood Building, Singapore, 349544

KENWOOD ELECTRONICS (MALAYSIA) SDN BHD
#4.01 Level 4, Wisma Academy Lot 4A, Jalan 19/1, 46300 Petaling Jaya, Selangor Darul Ehsan,
Malaysia